

NINETY

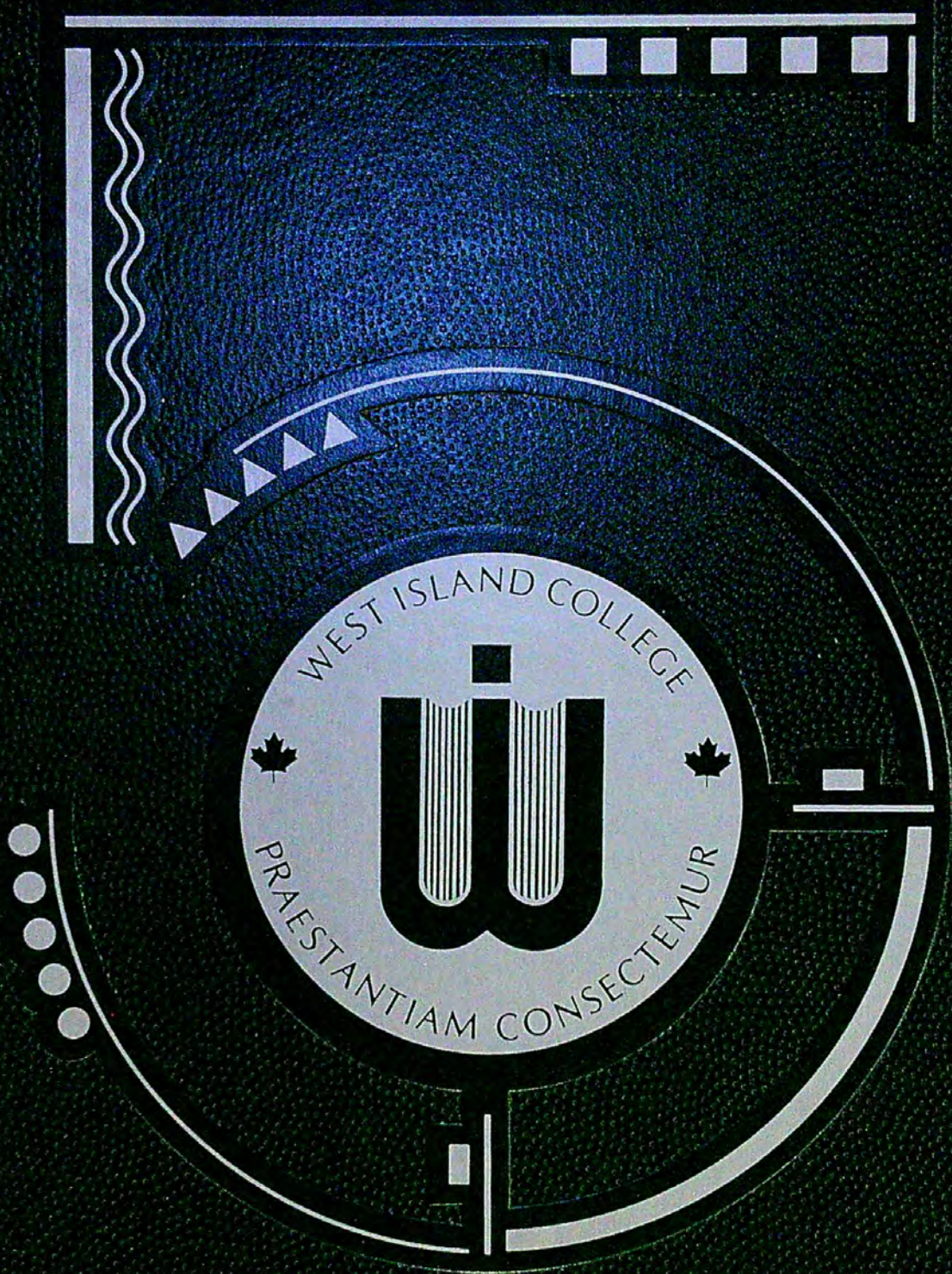

ROLAND CHALIFOUX



VOYAGES '95

The West Island College, Calgary, 1995 Yearbook: The first year in our new Blackfoot Trail home (above), and the first of many more years of smiles and memories (Artwork below by Stacy Soutiere, Grade 10).

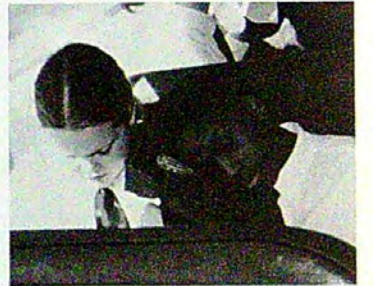

Stacy Soutiere '95

Voyages '95

The West Island College, Yearbook Staff,
Introductory Messages and Contents

Contents

- 1 Inside Cover
- 2 Yearbook Page & Contents
- 3 Director General's Address
- 4 Headmaster's Address
- 5 Board of Governors' Address
- 6 Staff
- 8 Prefects
- 9 Students Council
- 10 New School & Official Opening
- 12 Experiential Education Intro & Grade 9 Trip
- 13 Senior Canoeing Ex. Ed. Trip
- 14 Grade 8 Rock Climbing Trip
- 16 Grade 7 Class Photos
- 18 Grade 7 Color Experiential Education
- 20 Grade 8 Class Photos
- 22 Grade 8 & 9 Activities Color
- 23 Fun Day Color Activities
- 24 Grade 9 Class Photos
- 26 Senior Experiential Education Color
- 28 Grade 10 Class Photos
- 30 Senior Experiential Education Color
- 32 Grade 11 Class Photos
- 34 Graduating Class Introduction Page
- 35 Valedictorian's Address
- 36 Graduating Students Biographies
- 43 Graduates Candid
- 44 Graduation Ceremony
- 46 Graduation Dinner & Dance
- 48 Sports Teams
- 56 Ski Day
- 58 WICAA Awards Evening
- 60 Clubs
- 64 Art and Literature Section
- 76 Travel-Study Program
- 78 Hallway Candid
- 79 Staff Candid & New Student Candid
- 80 Open House
- 82 Steinway Concert
- 83 Face Painting
- 84 Halloween
- 86 Drama and Dances
- 88 Undergraduate Awards Ceremony
- 92 Alumni Night
- 93 10th Anniversary & Farewell Candid
- 94 Advertisements
- 96 Closing Art & Autographs



Yearbook Staff

(LEFT TO RIGHT) FRONT ROW: Morgan MacGregor (Junior Editor), Claudia Haas, Jill Marcotte, Jennifer Waslen (Assistant Junior Editor), Jessica Park, Lara Patterson BACK ROW: Matt Youens, Stacey Soutiere, Erin Lester, Ryan Lailey (Senior Editor), Jothy Sanghera, Teresa den Boef (Grad Editor), Mr. Rennie (Advisor)

Yearbook Editors' Message

This year the Yearbook Staff has been working very hard to bring the best W.I.C. Yearbook ever produced. We have been organizing meetings every Wednesday for the past 10 months as well as going to seminars. This year's book required the co-operation of our English teachers, Art teacher and the work of our advisor, Mr. Rennie. And finally thanks to all the students for their poses, stories, artwork and patience - this is your book! - Ryan Lailey and Morgan MacGregor.

Yearbook Advisor's Message

A yearbook is a very large endeavor, and the students who worked on this project should be complemented on their consistent year-long effort - from Jessica Park's hours of work on stories and copy to Morgan MacGregor's and Jen Waslen's work in setting up meetings and year-plans to Ryan Lailey's planning and advertising efforts, all the yearbook staff deserve thanks for a very big job, very well done. - Mr. Rennie.

DIRECTOR GENERAL'S ADDRESS - 1995

by Terry D. Davies

While we mark another year in this community that we conveniently, perhaps affectionately, call "W.I.C.", the rest of the world is not likely to remember who won our science fair, who went to Kenya and how many games were won by the girls' basketball team. The world outside of W.I.C. is likely to look back on this period in our lives and remember Forrest Gump, the O.J. trial, the Oklahoma disaster, the Ebola outbreak in Zaire, Bosnia's insoluble racism and resurging Russian imperialism. As teenagers, you will remember your close friends, your favourite music, your favourite artists, your hair styles, clothing styles and your first day with your drivers' license.

When I think of all that we tend to remember, I am struck by all that we tend to forget. 1995 marks the 50th anniversary of the end of the war to end all wars. Hundreds of thousands of soldiers died. Six million Jews were sentenced to death in human kind's most inhumane act. Millions of innocent citizens perished in Russia . . . in France . . . in Africa . . . in Japan . . . in England . . . in Scandinavia . . . in Hungary . . . etc.

As you look back in 1995, think not only of Forrest Gump or the Simpson trial. Remember this special year, it has obliged us to reflect on the events of 50 years ago; it has helped us reserve a space for values so very fundamental to our future.

I wish to take this opportunity to thank the editorial staff and advisors of this chronicle for their dedication to producing what is an excellent reflection of your time and voyages at West Island College.

Also, may I offer my best wishes to the graduates of 1995. Our memories of your time here and your many wonderful contributions will not be forgotten. Lest we forget.

Carpe diem.

The four corner photos show the poppies that have grown outside the window of Mrs. Bedard's room in one corner of our new school and serve to illustrate the theme of the address on this page.



Headmaster's Address

by Jack A. Grant



Voyages Chronicles one year at West Island College; its pages are filled with the memories which evolved from Fun Day to Graduation Day, from September to June. The 1994-1995 school year has been an incredible adventure. We as a community have thrived in an atmosphere of change, rejuvenation and progress. A new building, new courses, new procedures and a new Headmaster have all been a part of this year. We have more than survived, we have prospered.

I would like to thank the Class of 1995 for the contributions its members have made to this past year. Next year for them will be exciting as they apply their W.I.C. education to the rigours of post secondary studies - I know they are well prepared, come back to visit.

To the students who are leaving our community: good luck, we wish you well.

The 1995-1996 year is just around the corner and it promises to be just as fulfilling as its predecessor. I wish each of you a great summer and I look forward to our continued "Pursuit of Excellence" in the new school year.

Sincerely,

Jack A. Grant
Headmaster



Board of Governors' Address

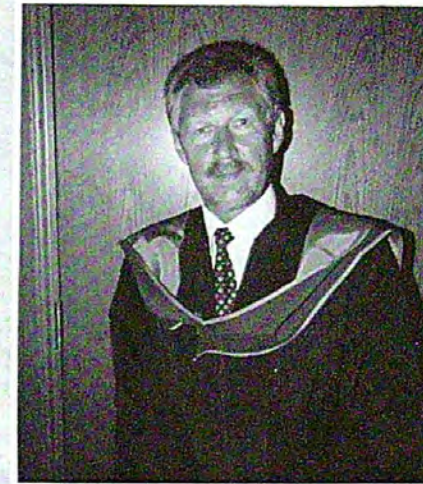

Graduation Address by Dr. Frank G. Bercha Chairman Board of Governors June 16, 1995

Graduates, ladies and gentlemen . . .

Today I'd like to talk about fate, destiny, and choice. This is neither an easy, nor common subject, but it is an important one and I hope you will find my message useful, particularly at this exciting and vital point in your development.

But I'll make considerable use of what has already been said on the subject by some very learned people. To begin with, William Shakespeare sets out all the main elements of the subject in the well known speech by Brutus in Julius Caesar.

There is a tide in the affairs of men
Which taken at the flood leads to fortune;
Omitted, all the voyage of their life
Is bound in shallows and in miseries.
On such a full sea are we now afloat,
And we must take the current when it serves,
Or lose our ventures.

Fate and destiny are the "tide in the affairs of men" and we must choose to "take the current when it serves." In general, fate and destiny refer to any one or series of unexpected events beyond our control, which have a significant effect on our lives. And it is the timing of these events which is often critical.

For example, if you are a competitive athlete, as many of you are, an accidental injury, such as a sprained ankle, may not be important in mid season or off season, but if it happens the day before tryouts or training camp, it could have a major impact and change your future in the sport. We say it was fate -- fate is bad destiny. Essentially, fate and destiny are the same kind of thing -- destiny is associated with a good outcome, fate, with a bad outcome, but both are outcomes that appear to be driven by factors beyond our control.

Certain cultures accept foreordained fate more than others; for example, from the Persian distich by Ali Taleb,

On two days it steads not to run from thy grave
The appointed and the unappointed day
On the first neither balm nor physician can save
Nor thee, on the second, can the universe slay.

In contrast, the great American 19th century thinker, Ralph Waldo Emerson says in his essay on Fate,

If we must accept fate, we are not less compelled to affirm liberty, the significance of the individual, the grandeur of duty, the power of character, but he also maintains a certain inevitable aspect in fate,

A man's power is hooped by a necessity which, by many experiments, he touches on every side until he learns its arc.

In either case, destiny and fate can be considered a part of reality, but there is some divergence in opinion on just what can be done about them.

So why did I choose this subject? Many believe fate and destiny are reserved exclusively for the heroes and heroines of Greek tragedy -- people don't think it applies to them. But it applies to every one -- and I would like to provide some useful perspectives and practical advice on how to deal with it -- some wisdom from experience.

You may think that fate does not affect you, but sooner or later that universal pitcher will throw you a curve ball at full count and you will strike out.

What is important is that striking out is not necessarily the end of the game, or the series, or the season, and even if it is, you have to deal with it by making choices. As Emerson states,

One key, one solution to the mysteries of the human condition . . . of fate, freedom, and foreknowledge exists, namely the propounding of the double consciousness. One must ride alternately on the horses of destiny and choice, as the equestrians in the circus throw themselves nimbly from horse to horse, or plant one foot on the back of one and the other foot on the back of the other.

So it is really important to make a quick and nimble recovery from fate or destiny to choice, and be prepared to change plans. From Emerson's essay on Self Reliance, to choose is,

To believe your own thought, to believe that what is true for you in your private heart is true for all -- that is genius . . . and we all have it.

And we must not be impaired by a blind belief in the status quo, in old plans, for,

Whosoever would be a man; must also be a nonconformist . . . and,

A foolish consistency is the hobgoblin of little minds, adored by little statesmen and philosophers and divines . . . Speak what you think now in words as hard as cannon balls, and tomorrow speak what tomorrow thinks in hard words and within the constraints of fate and freedom, destiny and liberty, I say to you, graduates, make your choice, and, in Emerson's words,

Hitch your wagon to a shooting star!

Thank you.

THE STAFF

of the Calgary Campus of West Island College

This staff is not getting older, they're getting better. At least about hiding their true ages. Seriously, everyone here has enthusiasm and dedication and knows how to help the students both learn and have fun learning. The staff of 1994-95 are all here except for Mr. Parnell, who once again chose to be included in the Art section of this book (although the notion that Mr. Parnell is a work of art does not have unanimous approval from the rest of the staff).

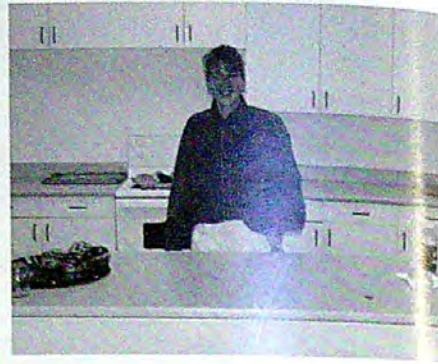

ABOVE: Kelly Mantei smiles from her lunch counter. Kelly worked as school supplier, scheduler and provided hot meals out of the kitchen next to the Great Hall. This food service was one of the most appreciated improvements about the move to our own new building.



Jack Grant

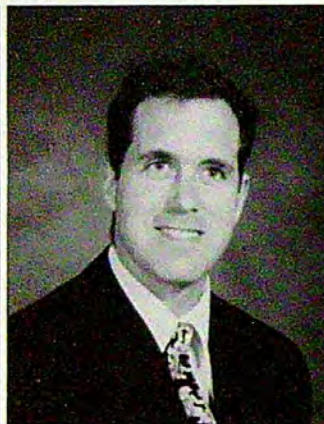

Darren Forrester



Tina Butz

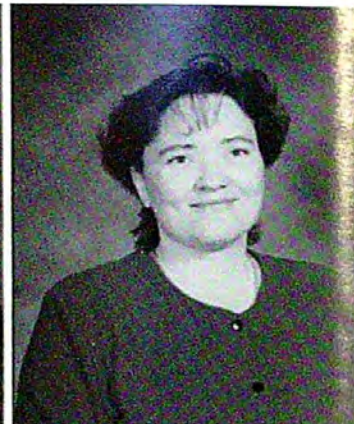

Marie McDonald

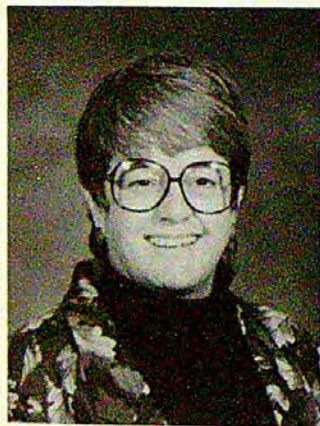

Agnes Bedard



Sylvie Bouchard



Carolyn Breland

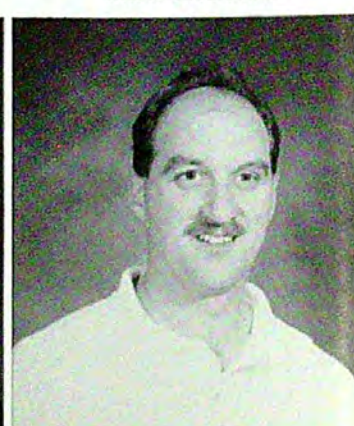

Roland Chalifoux

WEST ISLAND COLLEGE, CALGARY, STAFF . . .



Nadine Flottat

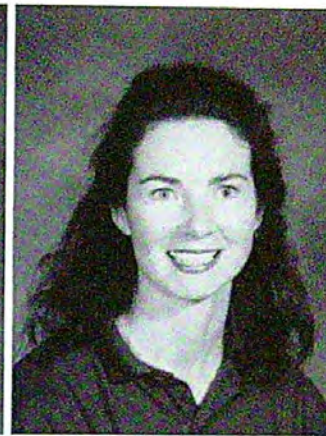

Shannon Gillies

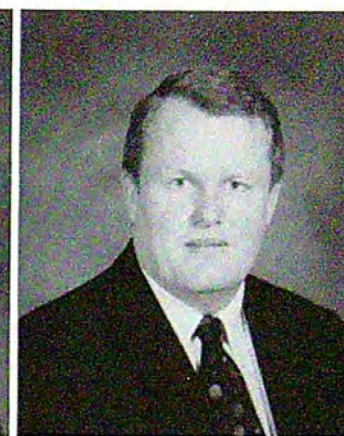

John McClintock

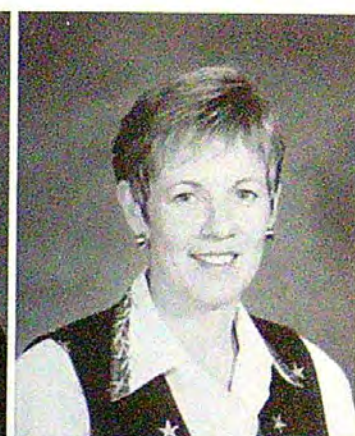

Wendy McGee



Theresa Morin



Kimberly Ormrod

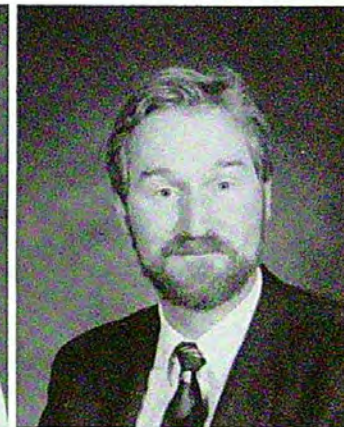

Pierre Poitras

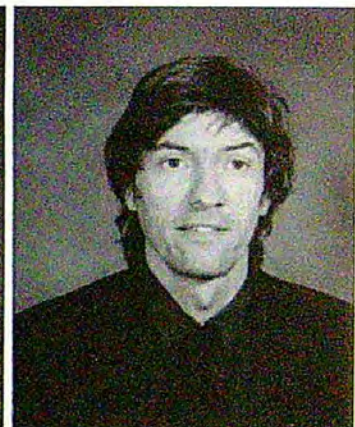

Malcolm Rennie



Steven Smith

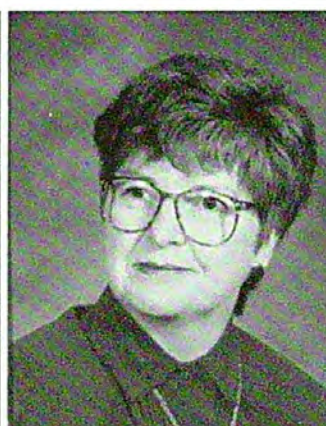

Aude Volstad



Kim Whitehead

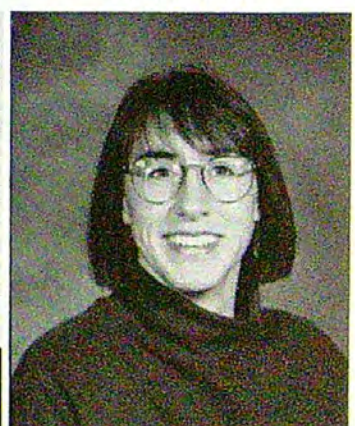

Philippa Webb-Briscoe

THE CLASS OF 1986 ON AVERAGE (& IF YOU BELIEVE THAT . . .)

Prefects

Message from Head Boy and Head Girl

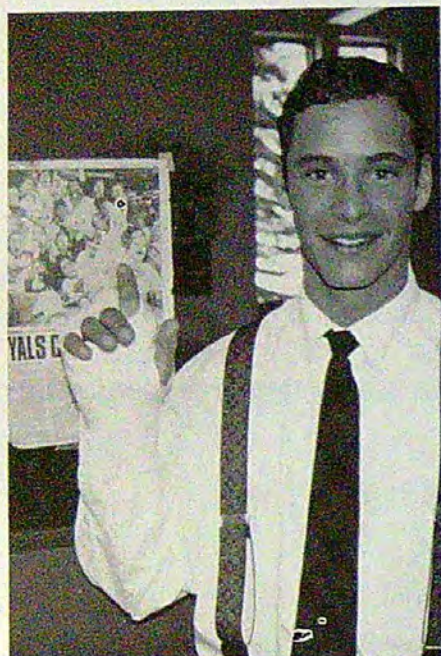

It is easy to say that the past six years at WIC has been a challenging process, yet the 94/95 school year was the greatest challenge. It was difficult adapting to the new environment and new set of rules given to us, but we worked through it as a group and it ended up being one of our best years. Taking on the role of Prefects has enabled us to mature, become more responsible, and most of all develop leadership qualities that will help us with the challenges that will present themselves in the future. We wish the best of luck to the 95/96 Prefect Board and hope that their journey is as satisfying as ours was.

Thanks to Mr. Grant, Mr. Forrester, Mr. Rennie, Mrs. Volstad and the rest of the teaching staff for their support.

- Shaun Ford and Abena Boadi, Head Boy and Head Girl

(LEFT TO RIGHT): Michelle Chenery, Neil Gohill, Matt McLeod, Shaun Ford, Jeremy Freeborn, Abena Boadi, Alim Mawji, Andrea Hamel, Anita Fofie, Kim Linder, Amy Skinner



Students Council



Students Council Message

This year, Students Council organized many events. With the guidance of Mme. Breland and Mrs. McGee, President Alim Mawji, and Vice-President Kian Rasa arranged many dances, 'candy-grams', and fundraisers to support various charities. They made this year a great one!



Students Council Members

(ABOVE) (LEFT TO RIGHT) FRONT ROW: Dennis Lambert, Jill Marcotte, Callum Patterson, Christy Skinner, Andrea Remington. BACK ROW: Mrs. McGee (Advisor), Kian Rasa, Glenn Pickard, Alim Mawji, Ms. Breland (Advisor)



*Official
Opening
of
the
New
School*

On September 27th, 1994 the new building for the Calgary campus of West Island College was officially opened. Pictured above are, from left to right: Stavro Melathopoulos, the architect of the new school; Jack Grant, the Headmaster of West Island College in Calgary; Terry Davies, the President of West Island College; Frank Bercha, the Chairman of the Board of Governors, West Island College, Calgary; Michel Martin, Headmaster, West Island College, Montreal; Darren Forrester, Assistant Headmaster, West Island College, Calgary.

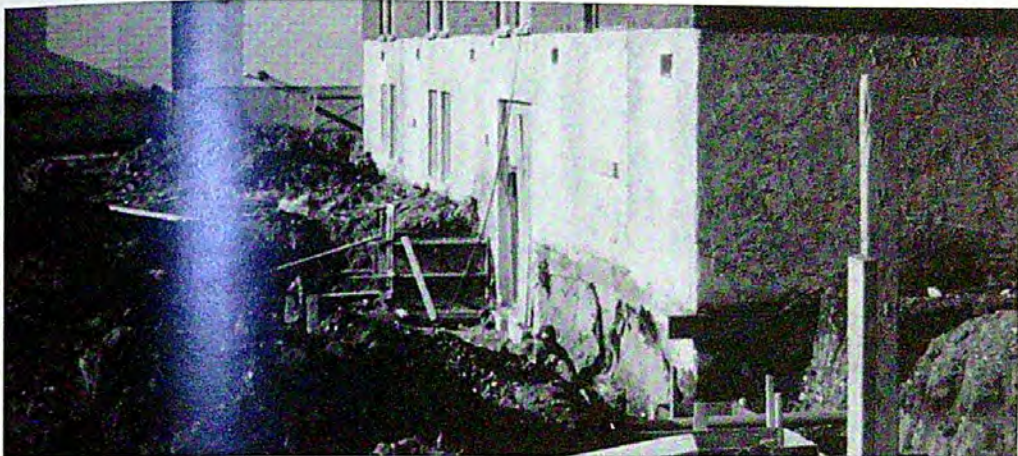
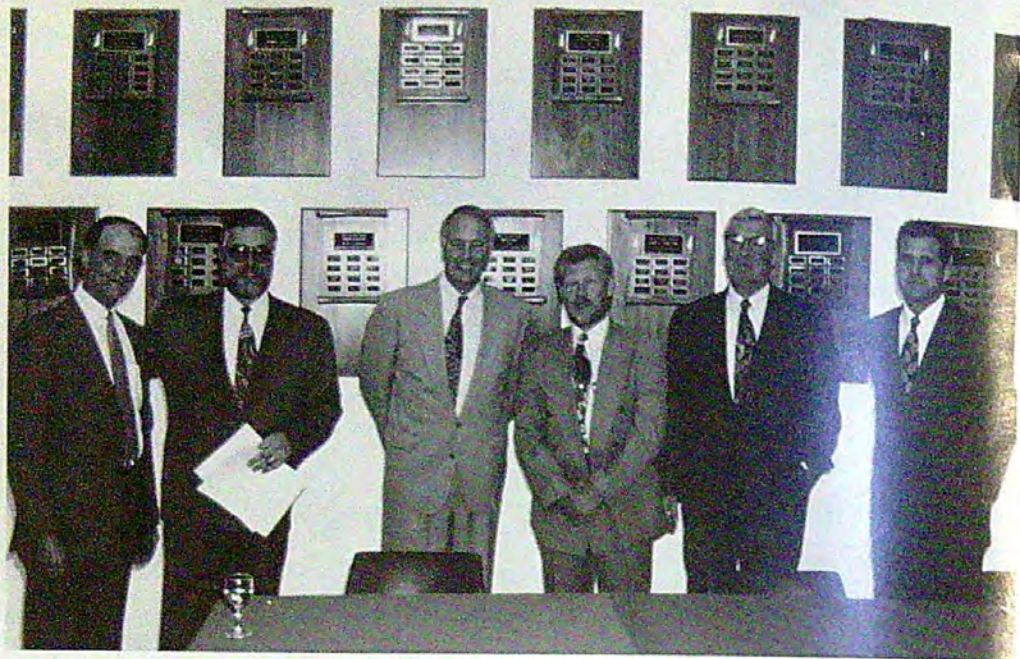

This page shows the transformation of the former building on this site into West Island College. The renovations and reconstruction took several months, as the offices in the building were enlarged into classrooms, the library and labs were set-up and the gymnasium was added.

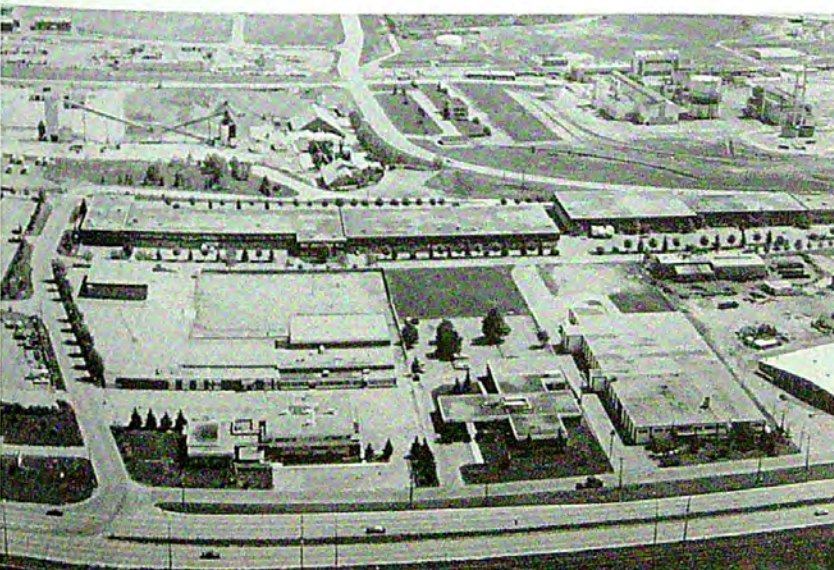
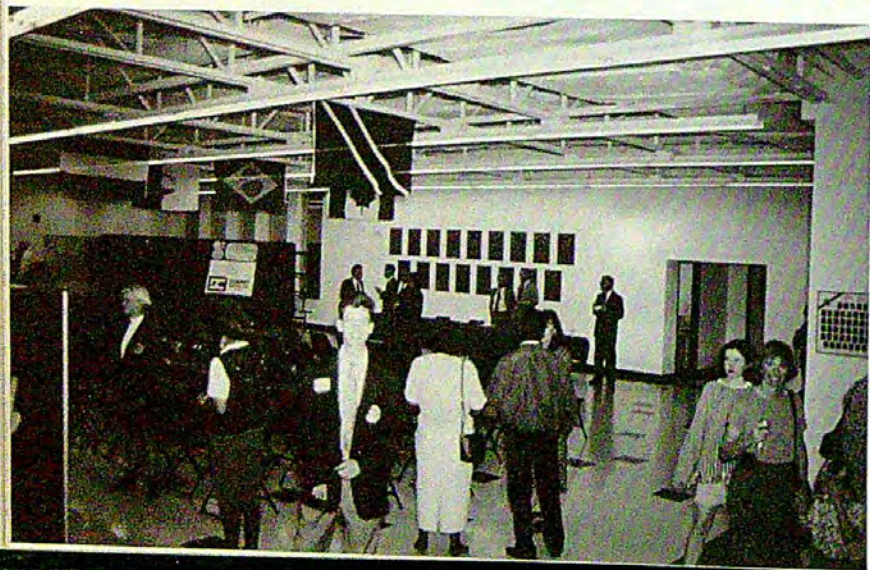

Experiential Education: The School Beyond WIC

Over the next twenty pages - combined with the class photos of Grades 7 to 11 - will be stories and photos on each of the outdoor education trips that each grade experienced. The experiential education program had the Junior School venturing out as grades, and the Seniors from grades 10 to 12 grouped according to their choice of activity. The first few pages will display the Grade 9 cross-country ski trip and Grade 8 rockclimbing, as well as the Senior school Canoeing trip. Then the grade class photos begin along with the Grade 7 camp-out and the other Senior School activities.

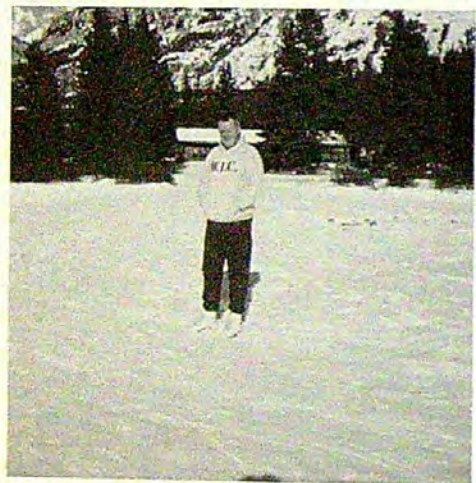

Grade 9 X-Country!

The Grade Nine Experiential Education trip took place at the end of February. It was three beautiful, sunny days of cross country skiing in the Peter Lougheed and Kananaskis Provincial parks, even though the snow was a little icy. Top left is Callum P. looking cool, above is Mr. McClintock all decked out in W.I.C. gear, and at the right - what can we say . . . MMM . . . MMM . . . Shreddies!



Senior Canoeing

One of the Senior trips was canoeing, and some students had a few problems with that concept. As you can see by the overturned canoe, many had a hard time riding the rapids of the Kananaskis River. The Bow River was a little easier but there still were a couple of problems. We managed to get by all this and had a few laughs throughout. In the end, it was all worth it!



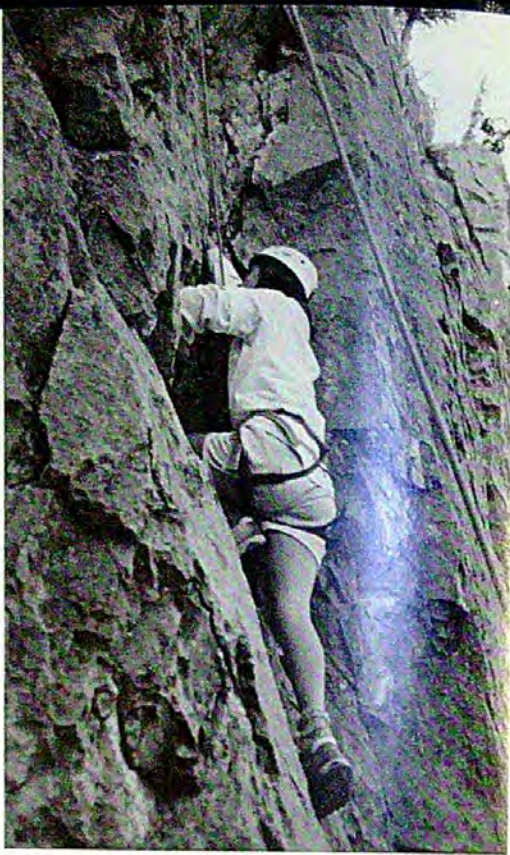

Grade 8 Rockclimbing

On June 8th the Grade Eight class went to Mount Kidd Campground in the Wasootch area of Kananaskis Provincial Park to go hiking and rock climbing. One group went to Mount Barrier to hike, while the other rock climbed at Wasootch; the next day the groups switched roles. At night we made a group fire and exchanged jokes. The teachers accompanying us were Mr. Forrester, Mr. Smith and Ms. Whitehead. Everybody seemed to have a good time rock climbing; while belaying was the most challenging part, and coming back down attached to the rope was the easiest.

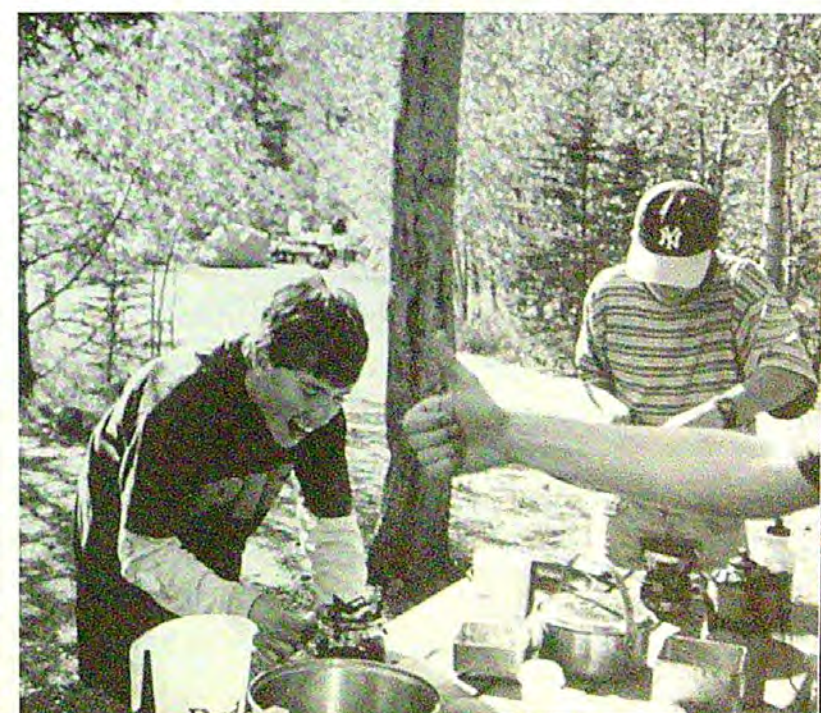
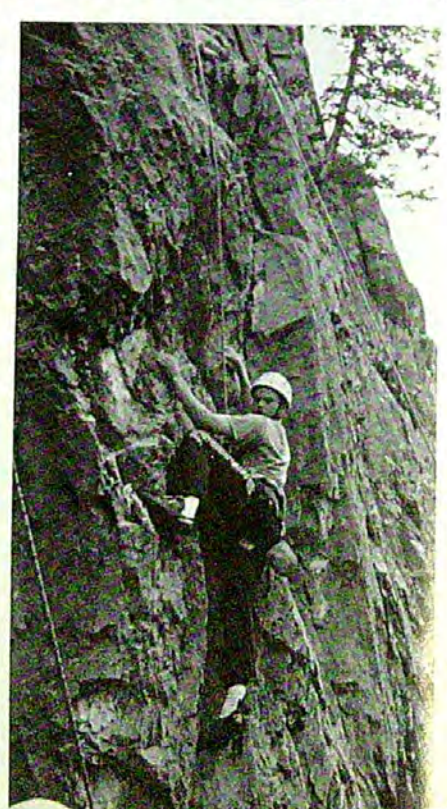
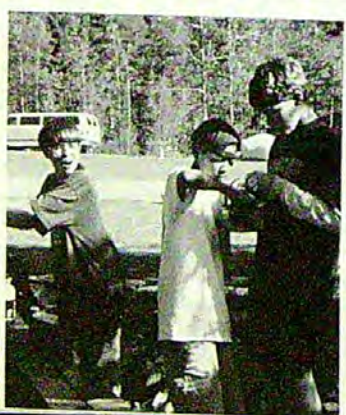
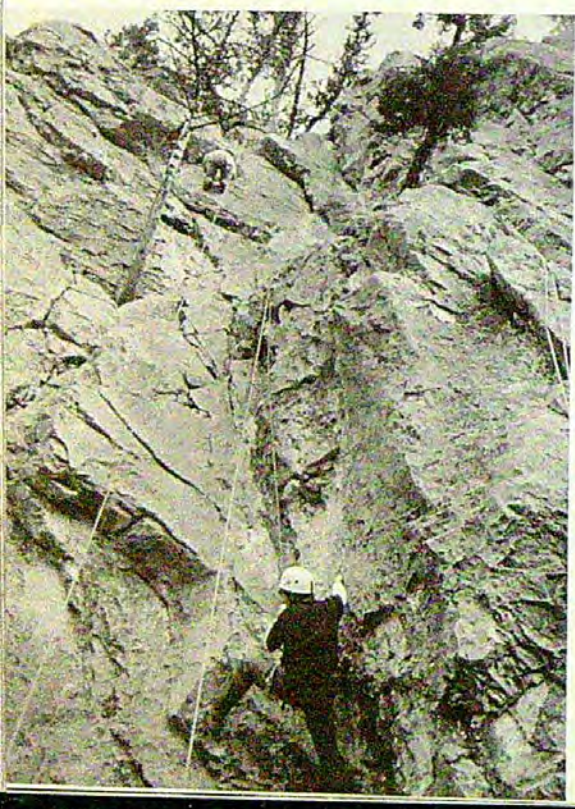
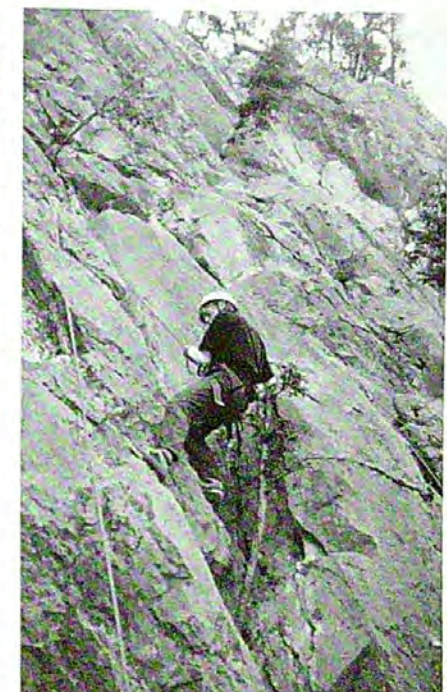

Carly Bindman
Nicole Cordeau
Jacqueline David
Karley DeNoon
Andrew Dickie

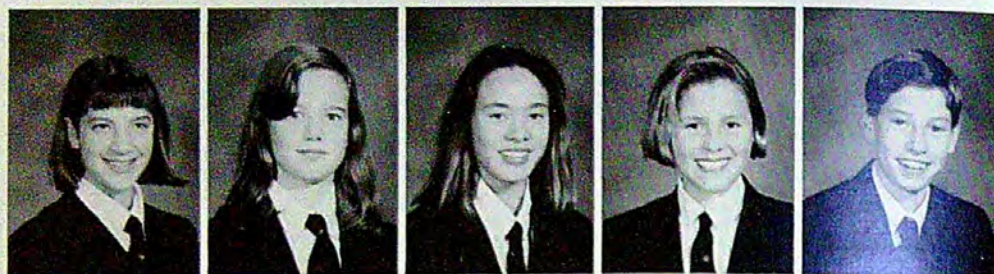

Andrea Elmore
Kate Elliott
Joseph Everett
Gillian Garrett
Alana Gillean



Jonathan Glass
Laura Grant
Jennifer Graas
Andrea Habermeyer
Vanessa Hare

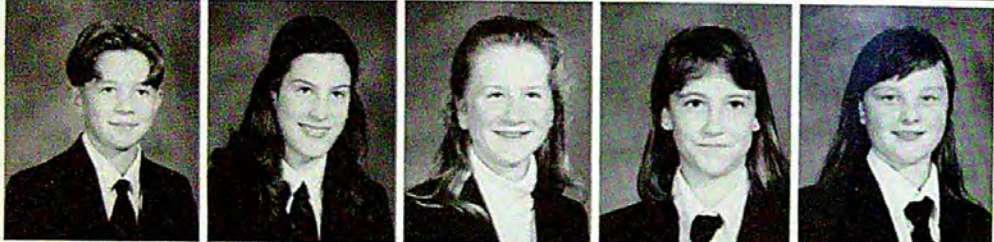

B.J. Herchuk
David Hofer
Connor James
Adriana Jamniczky
Andrew Keeping

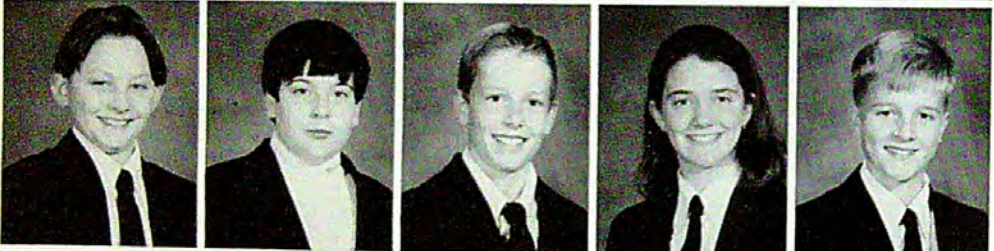

Jonathan Kelly
Elizabeth Klaiber
Dennis Lambert
Michael Lobsinger
Chelsea Luker

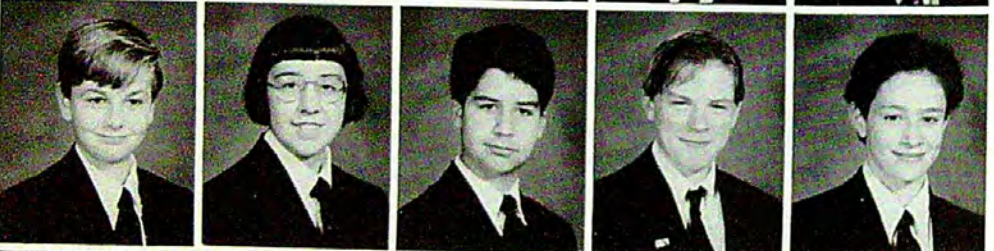

Neil MacBeath



The Grade Sevens

The Grade Sevens were up to many things in their first year as West Island College in 1994-95, such as a Pioneer Lodge camp-out, an 'Ann Frank' play staged for Open House, and the activity shown in the photo to the left. Close to Hallowe'en, we began making face masks with Madame Flottat. They were made out of plaster, gauze and water. We put them directly on our faces, let them form to the shape of our faces and then used blow dryers to have them harden. Then we used them for a play about animals in January!

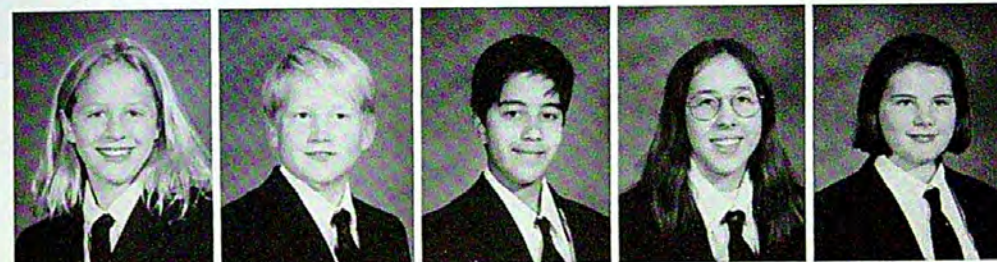

Emily Mackie
Parker Mason
Sameer Mawji
Laura McKinnon
Caitlin Moore

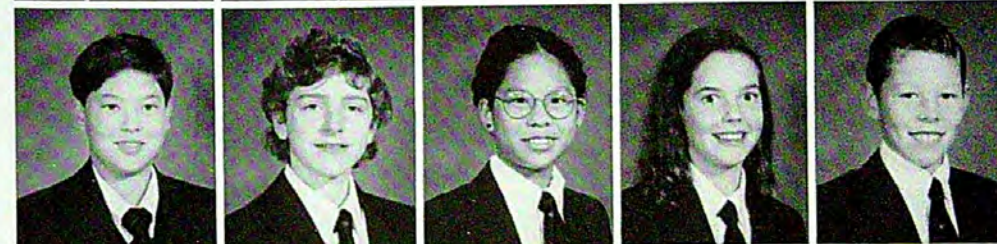

Christopher Murdoch
Aksel Nielsen
Valerie Obligation
Tasha O'Connor
Jonathan Owens



Christopher Radulski
Alex Sabey
Erik Scheel
Jennifer Steer
Tammy Sugimoto



Bruce Urquhart
David Watson
Jason Whitney
Lauren Wigham
Katherine Winters

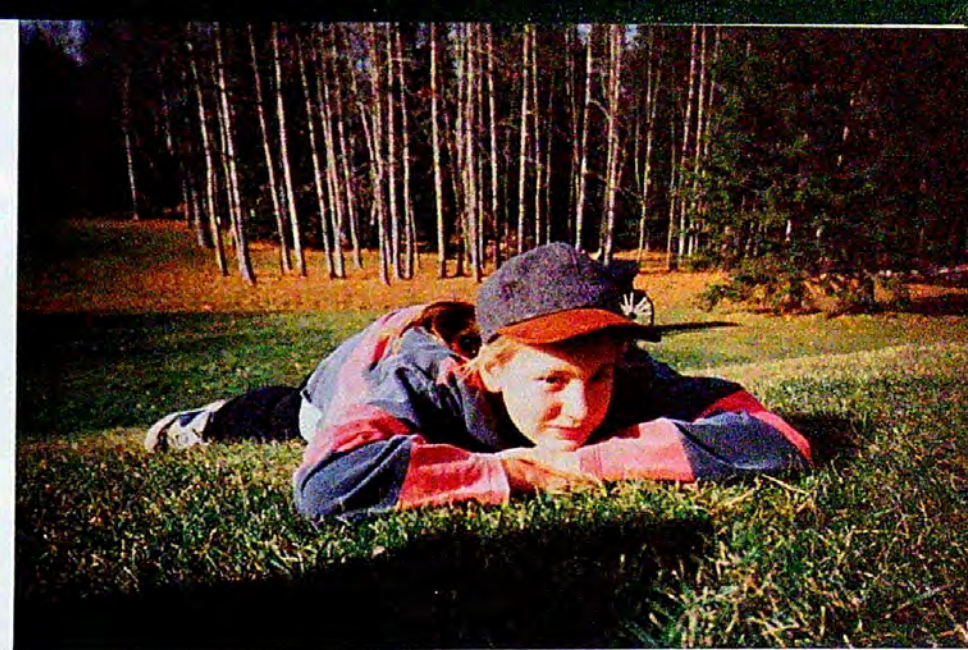
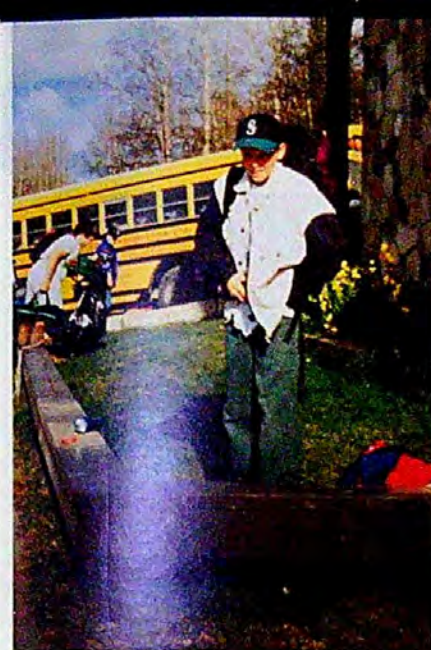
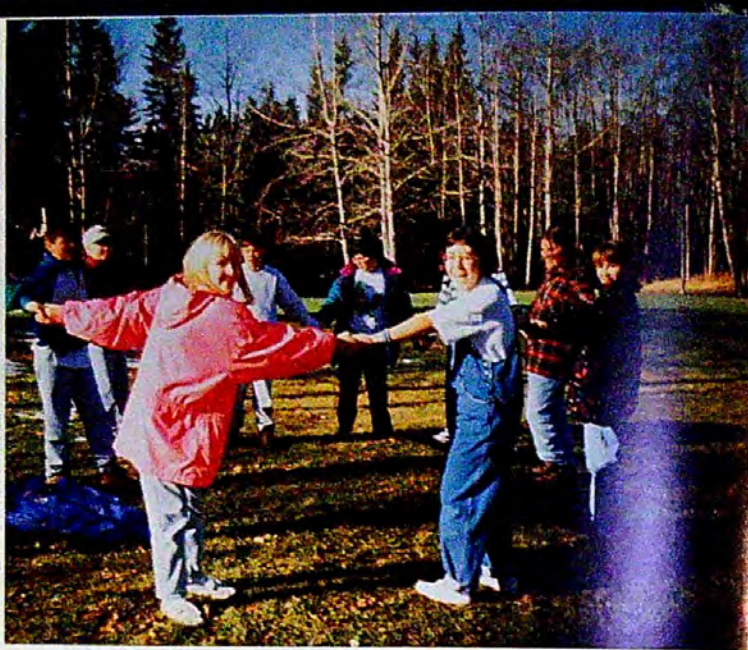
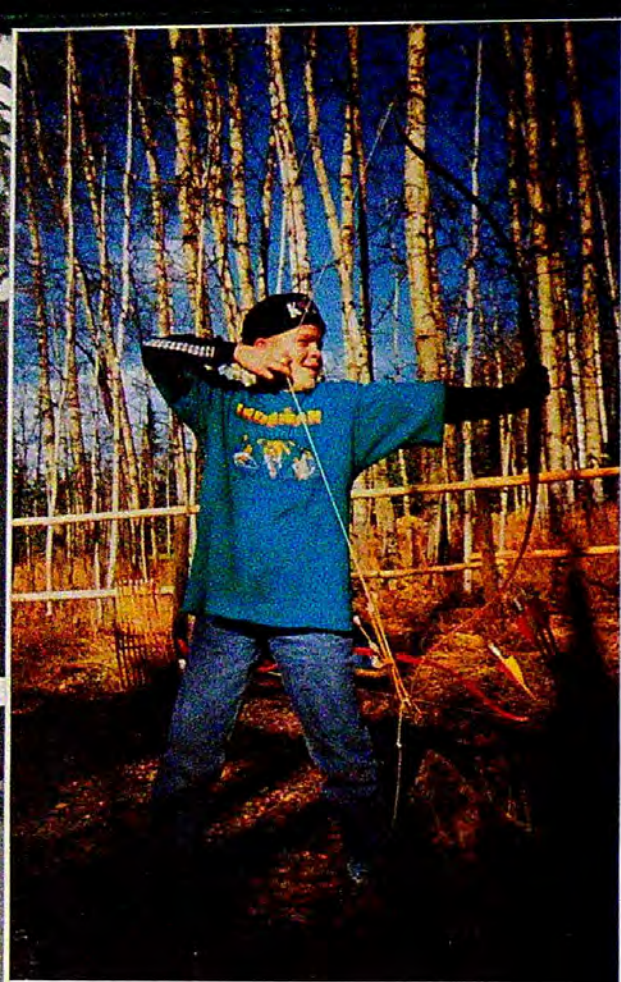

Grade 7 Experiential Education

As these photos show, the Grade 7 class enjoyed our trip to Pioneer Lodge, where our program of activities included orienteering, archery, a hayride, dodge ball, and an obstacle course built in the woods. Thanks to Mrs. McGee, Mlc. Breland, Mme. Flottat and M. Clarke for the supervision and all the activities.

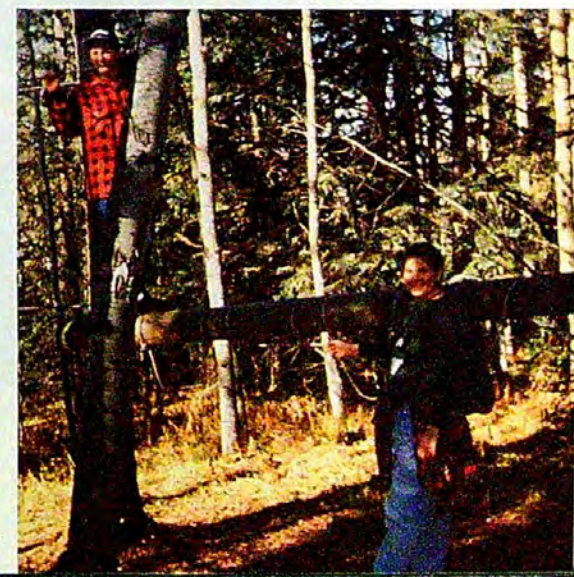

THE GRADE EIGHT CLASS

As Grade Eights, we knew how to have fun in 1994-95. For example at the Hallowe'en Dance, Mac Homme looked like he was having lots of fun surrounded by four girls.

Overall the year was full of spirit, good times and work (too much work it seemed). Highlights included trips, special projects and plays - in short, our grade did not mind calling attention to itself.

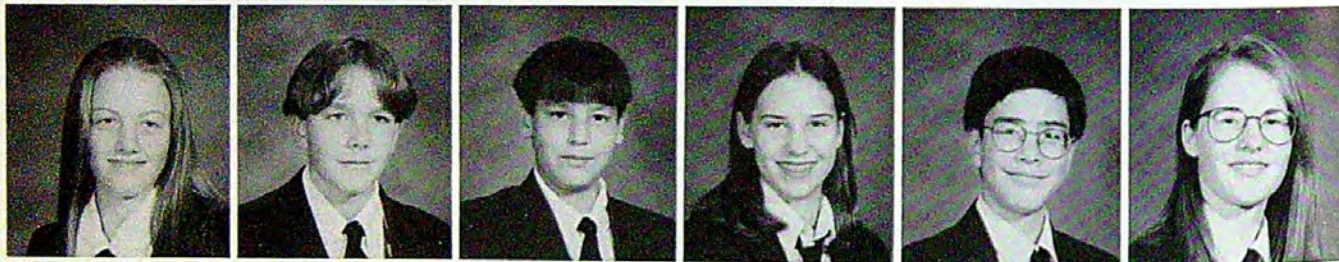
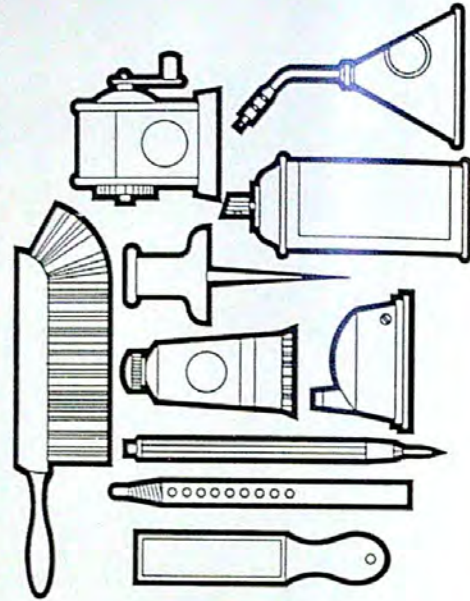
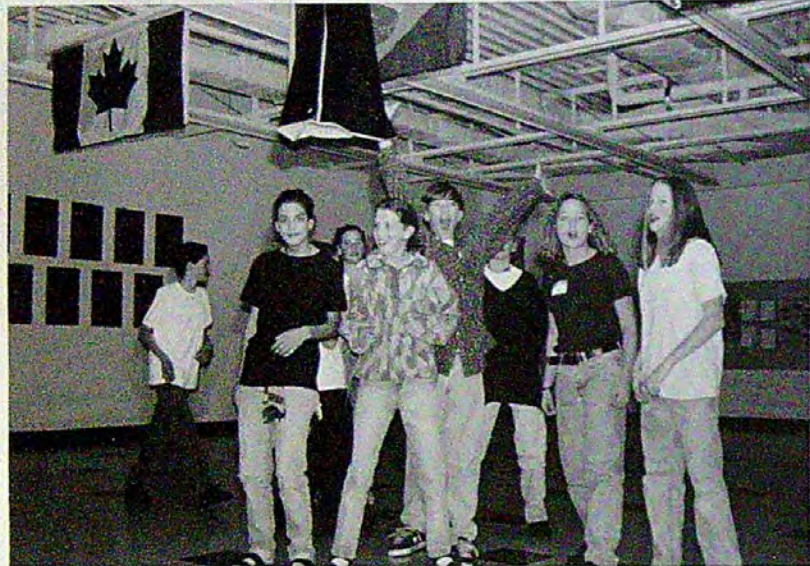

Julia Bouvry David Chalmers Kyle Chipman Mikyla Conway William Devlin Emma Duggan

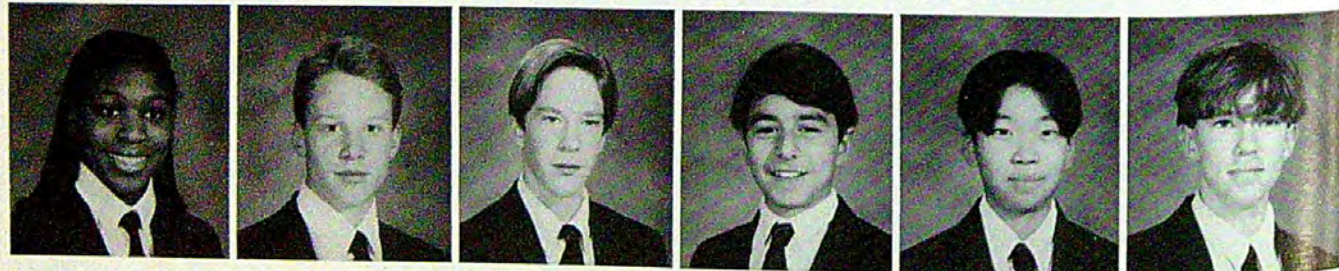

Desiree Fofie Austin Fraser Paul Gettis Fady Girgis Nathan Hayashi Mac Homme

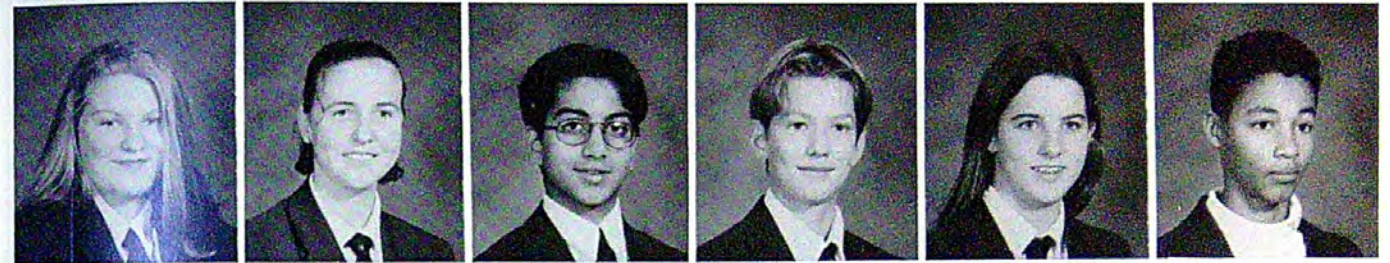

Alicia Hunter Vanessa Jacobs Alim Jessa Jeff Johnson Stephanie Keefe Ali Kellough



Lorraine Lau Erin Lester Dave Loftus Jill Marcotte John McGee Morgan McGregor



John Olson Jessica Park Amish Patel Lara Patterson Nicci Soutiere Adam Spragans

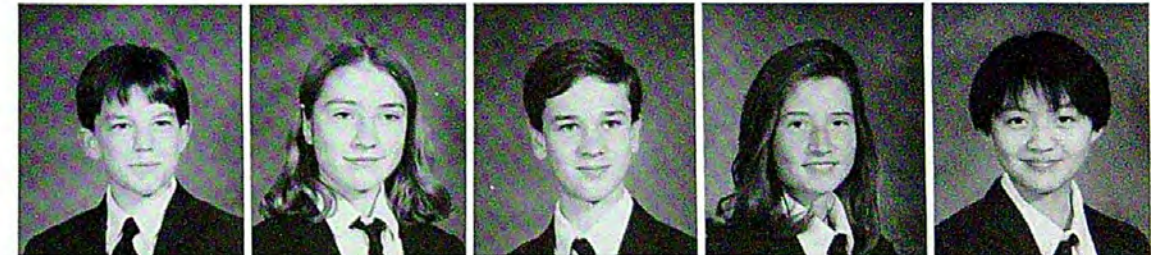

Kent Swanland Laura Tinline Ryan Vozzler Jennifer Waslen Sandy Wong

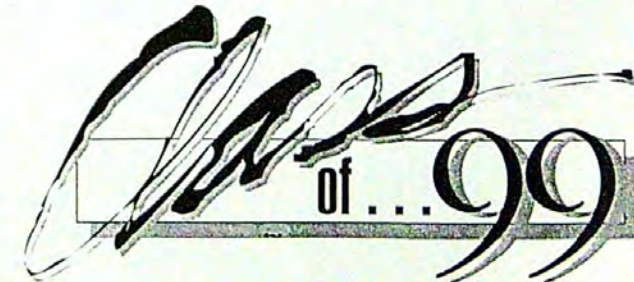

Grade 8 and 9 Activities

These color photos show just a sample of the many activities of these two grades, such as the Remembrance Day ceremony put on by the Grade Nines (complete with Callum Patterson's bagpipe introduction), and the Open House and in-class plays staged by the Grade Eights.

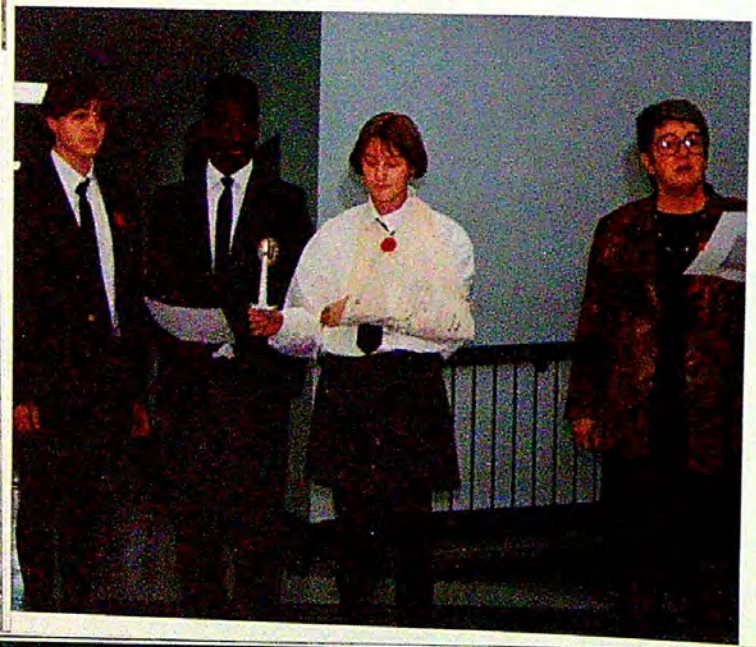
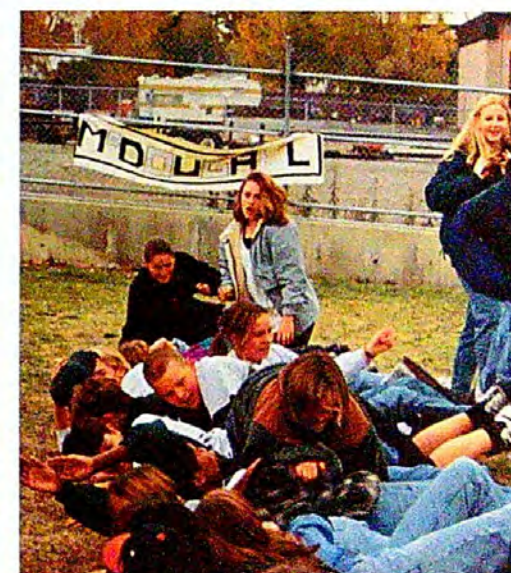
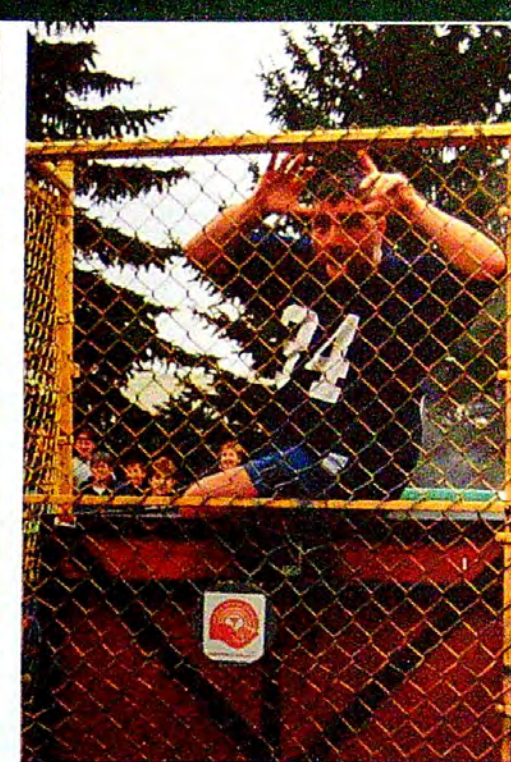
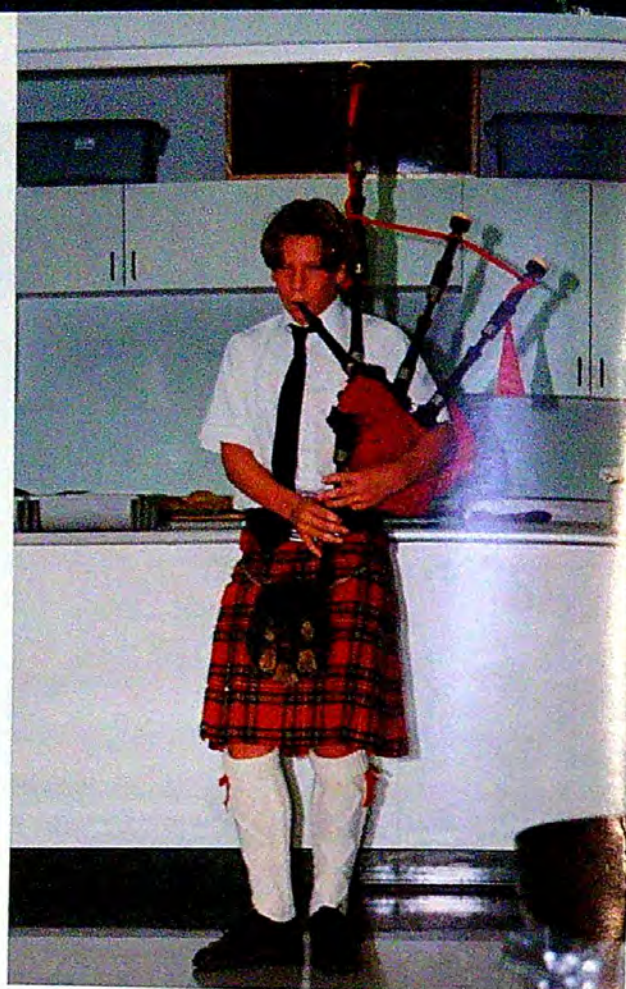

Fun Day!

This annual West Island College September tradition was delayed a month until the new gymnasium was completed, and that made it cooler for dunk tank volunteers such as Mr. Grant and Mr. McClintock. From tug-of-wars to body hopping, the event was once again a success.

GRADE NINES - CLASS!

Laurel Alexander
Nadia Barnieh
Kwasi Boadi
Jill Ewens



Daniel Gillean
Craig Goldie
Eric Grochowski
Shane Hare

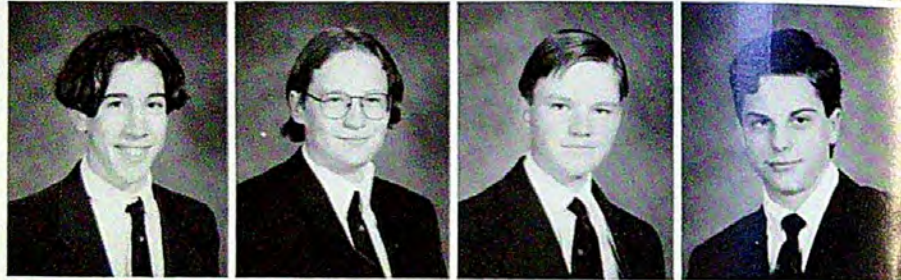

Davin Hensen
Craig Huber
Michelle Iverach
Lindsey Jager

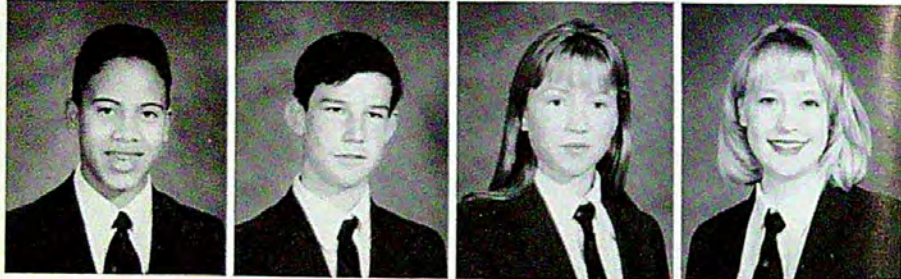

Stephen Jakubec
Michael Jarrell
Elizabeth Keith
Jordan Kim

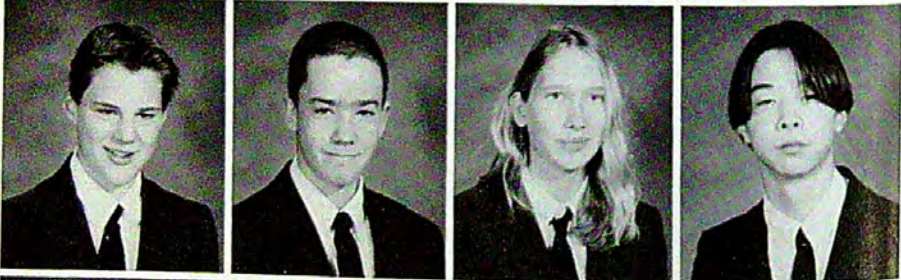

Jared LeBoldus



The Grade Nines were the senior class of the junior school, full of veterans of West Island College, showing the other junior students the way (whether they wanted to be led or not).

As shown below, for Remembrance Day, the Grade Nine Class, with the help of Ms. Morin and Mrs. Bedard, were bag-piped in, held candles, read poetry and led the assembled school in a moment of silence.

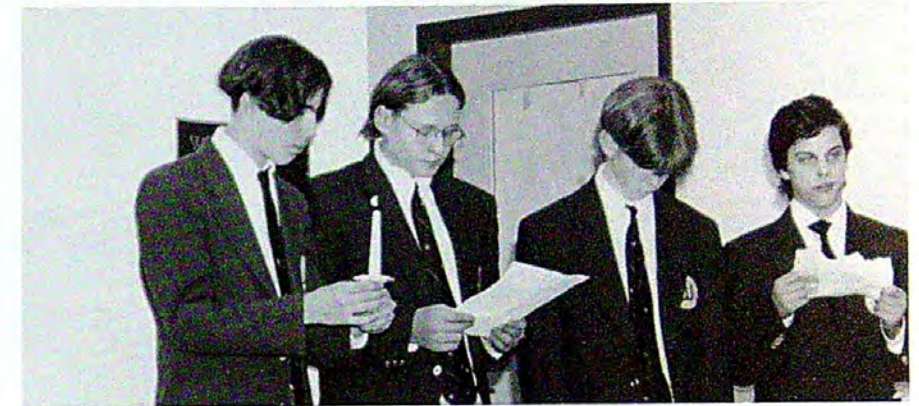

Jennifer Lester
Lorie Markowsky
Jonathan Miller
Callum Paterson

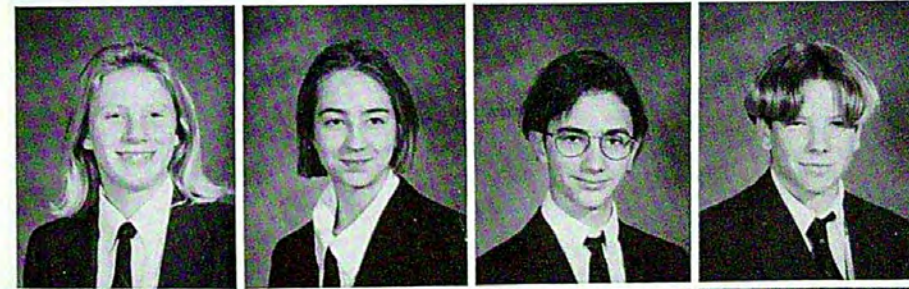

Nicole Raymaker
Steven Schuster
Christy Skinner
Daniel Stoffman

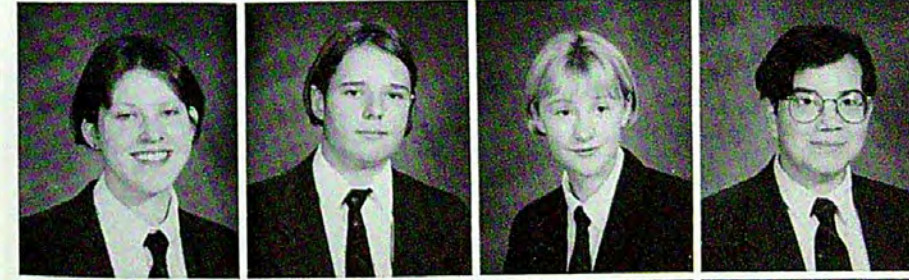

Kamil Umar
Laura Voszler
Marshall Wigham
Stephanie Winters

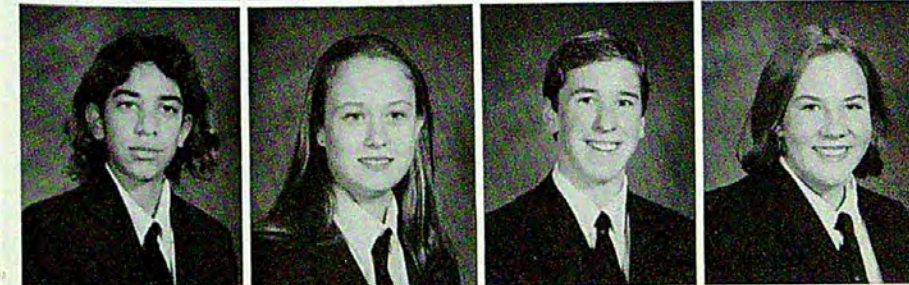

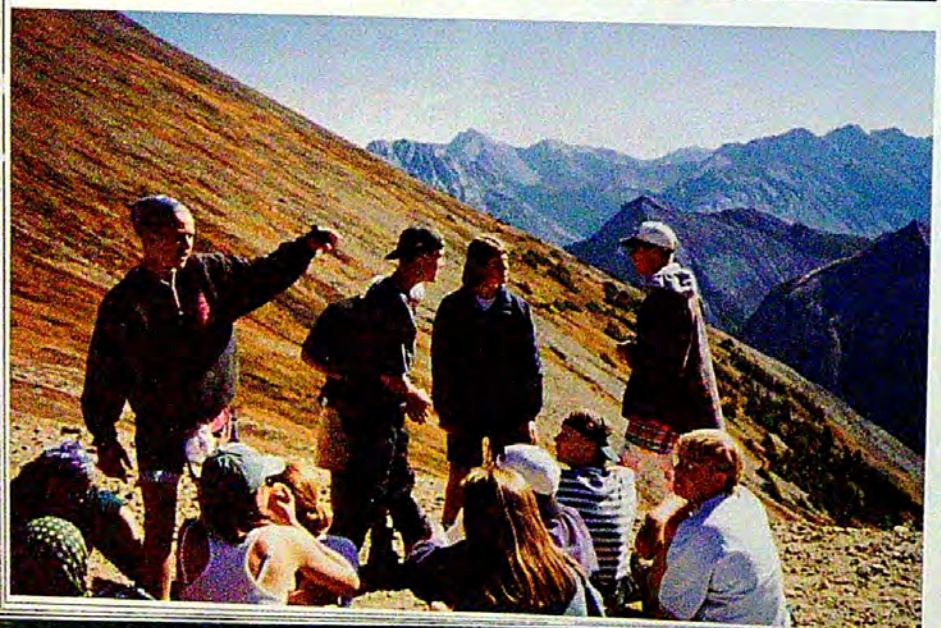
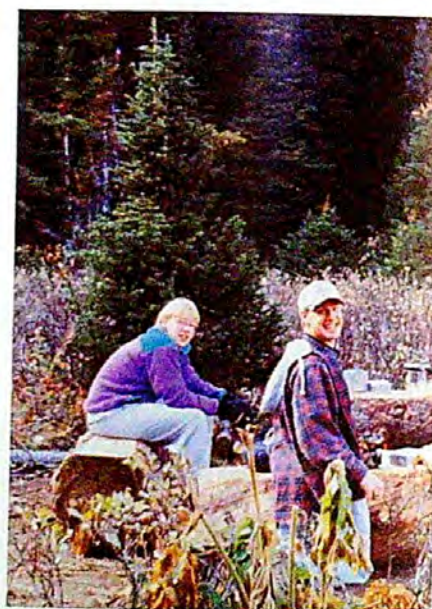
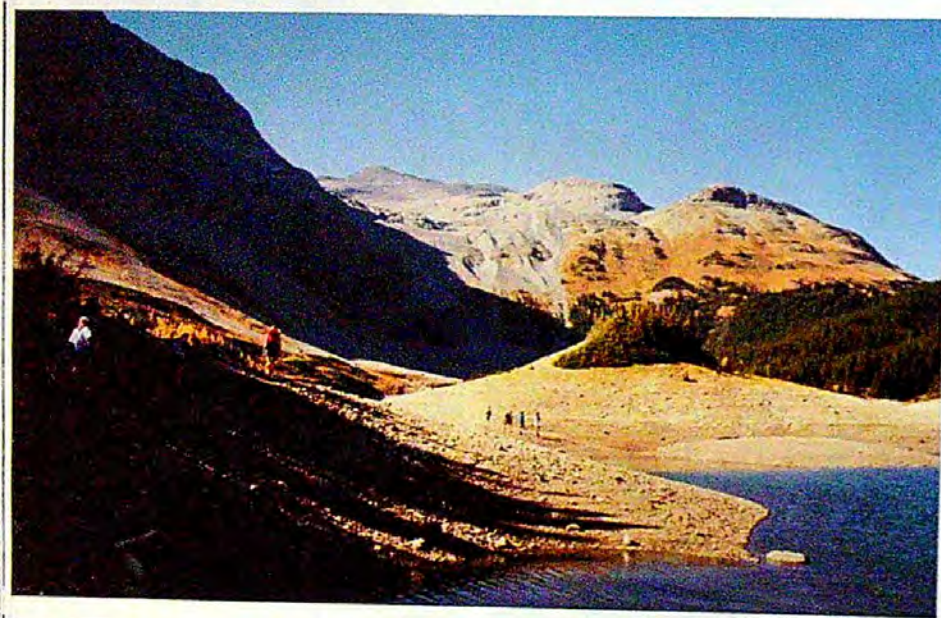
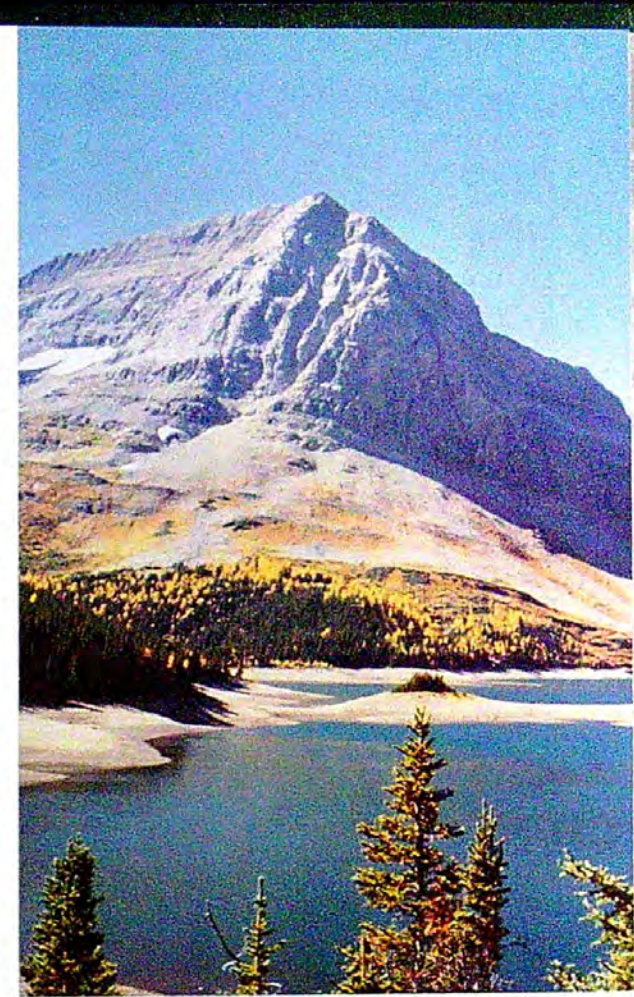
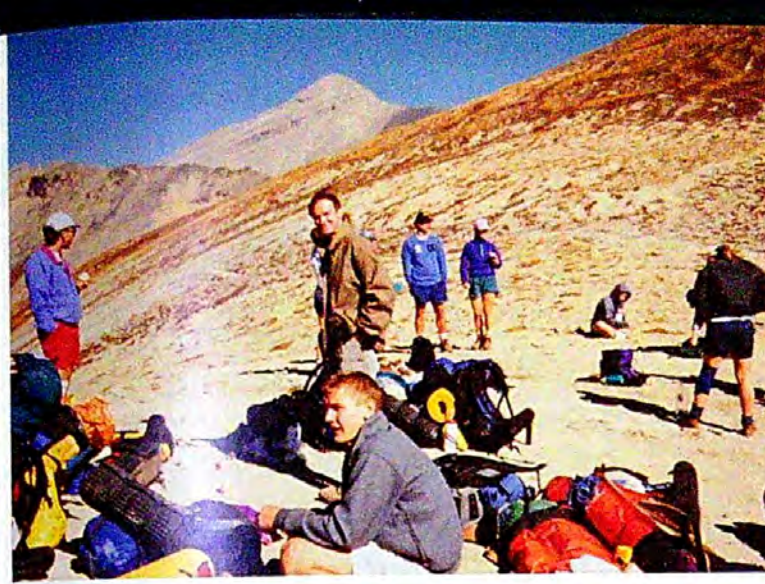
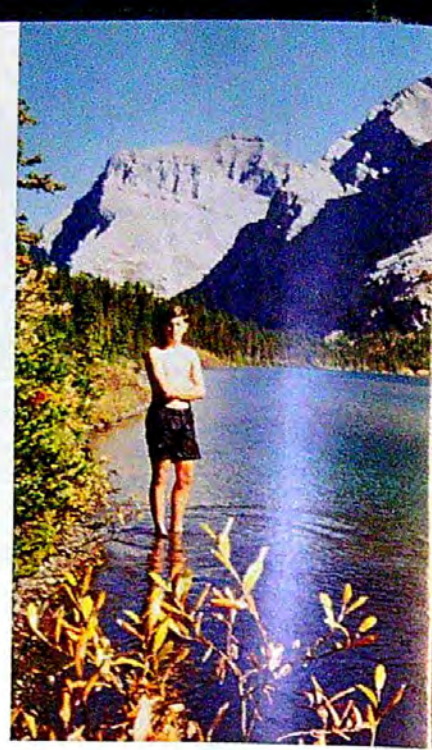
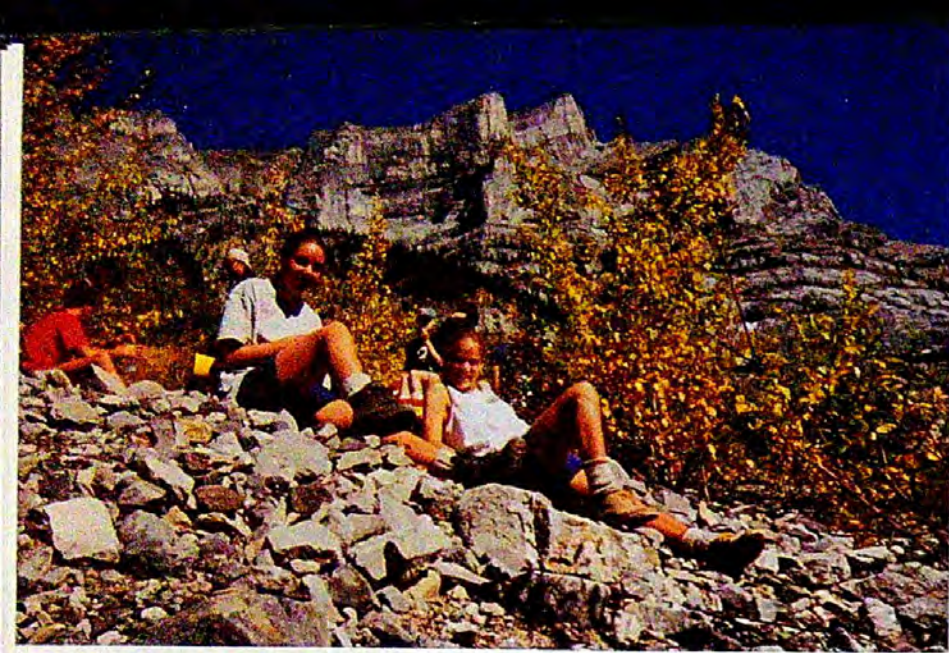

Senior Experiential Education - Backpacking!

Ms. Morin, Mr. Parnell, Mr. Chalifoux and Mr. Forrester all led groups of Grade 10 through Grade 12 students on overnight backpacking trips to develop their backcountry skills and take advantage of the magnificent scenery.

Rehana Allidina
Jay Banister
William Bercha
Jennifer Bourree
Clair Chalmers

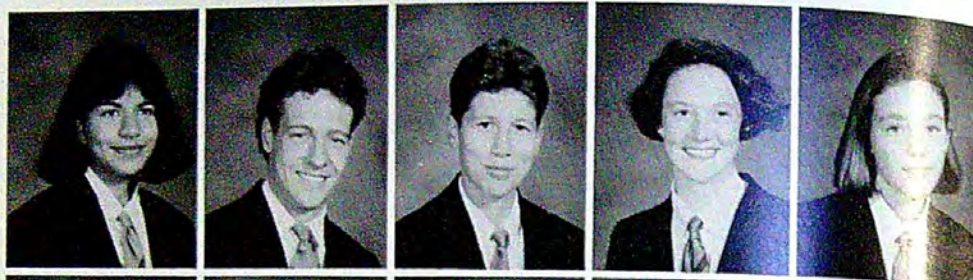

Emily Cram
Monica Fofie
Lucas Ford
Chris Forrest
Eric Gagnon

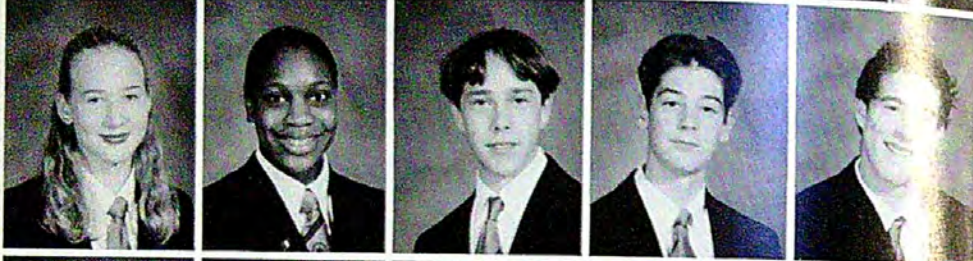

Stephan Gagnon
Quinn Griesdale
Claudia Haas
Kira Horstfall
Adriana Hunstad

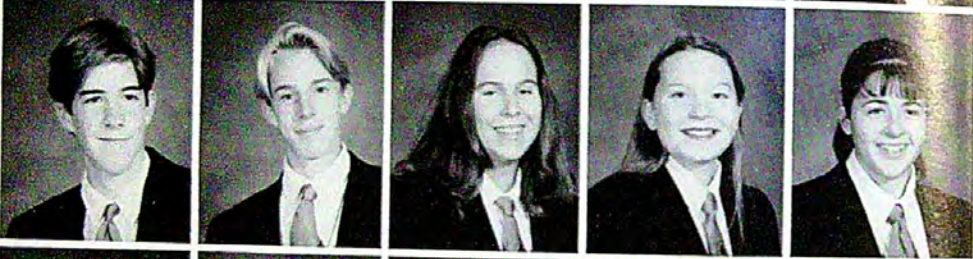

Shannon James
Heather Jamniczky
Jennifer Keele
Brad Klaiber
Jeff Lane



Grade Tens Assembled

Grade Ten was a great grade to be in this year. We had a mix of students returning to West Island from Junior High, plus a whole new crop of friends joining our school for the Senior High years. Meeting the other Senior grades on Experiential Education backpacking and other trips was a highlight of the year as well.

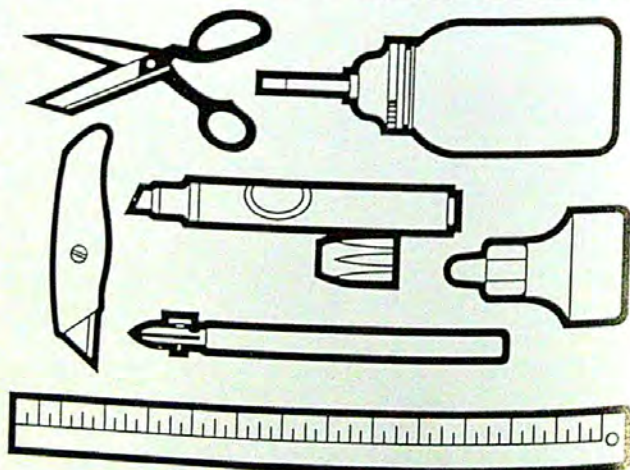

Nick Livaditis
Erica Lobsinger
Andrew Mayer
Garrick McIntosh
Brenda McLeod

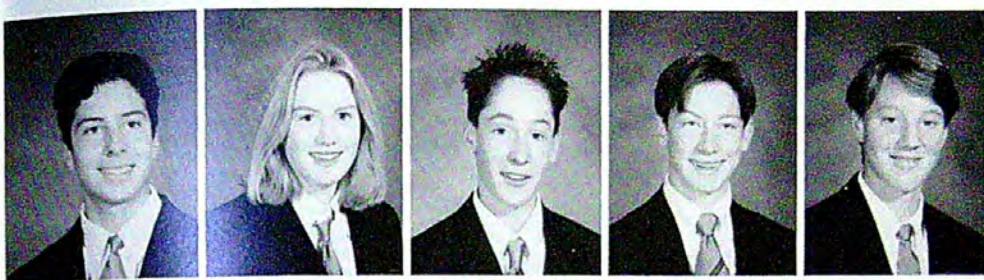

Mark Mjeda
Mark Payne
Josee Pilon
Michelle Raptan
Christina Reti

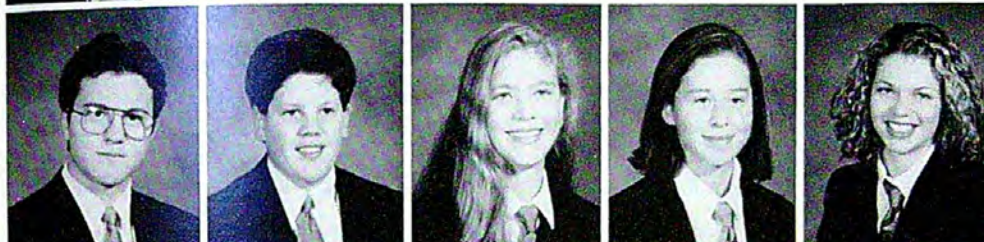

Stacy Soutiere
Natalie Stanhope
Chantelle Styles
Breanne Thomilson
Kathryn Tinline

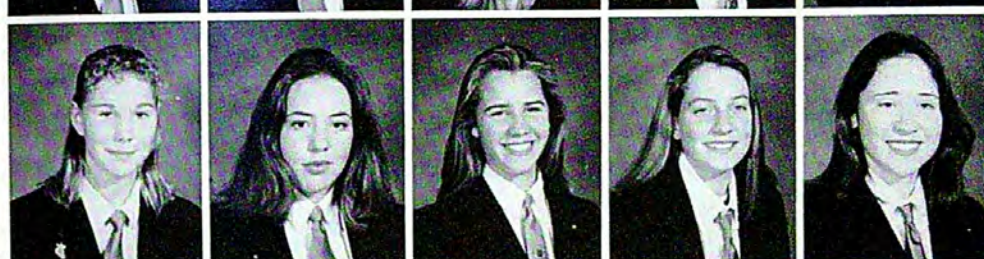

Crystal Walker
Winnie Wan
Liv Watson
Lathy Yeung
Matt Youens

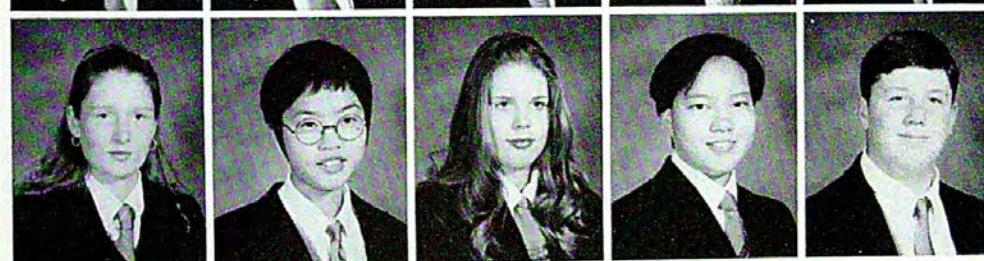

Nick Zikopoulos



Experiential Education - Scuba Diving

Ms. Gillies led our group of Senior Students on a three-day Scuba Diving adventure for their Experiential Education trip this year. These photos show the spirit of the event - Thanks to Ms. Gillies and the Dive Shop!

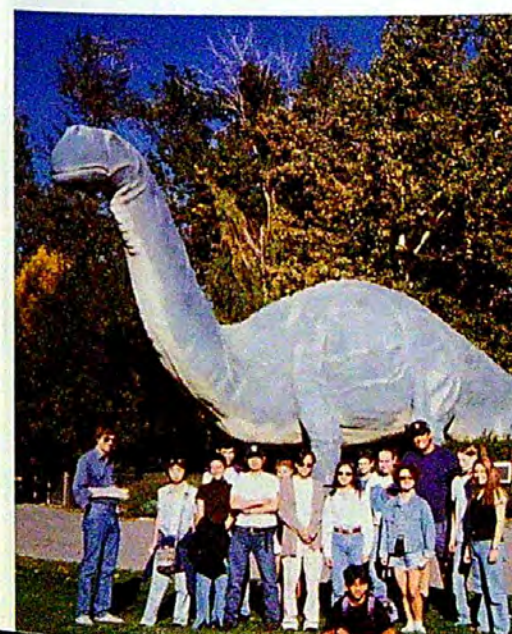
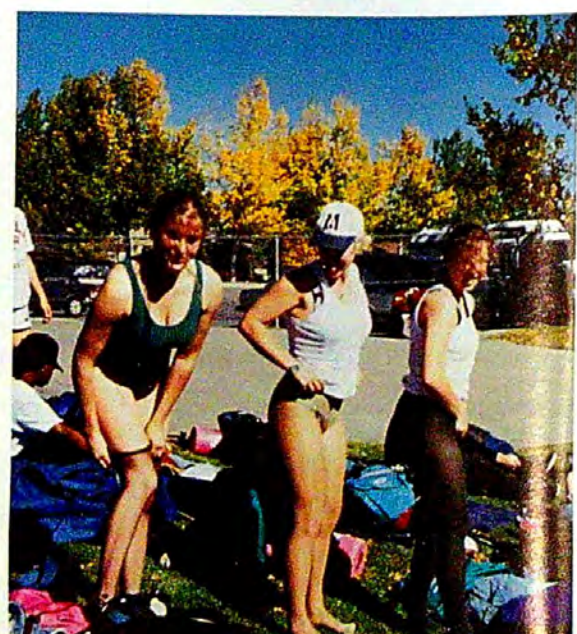
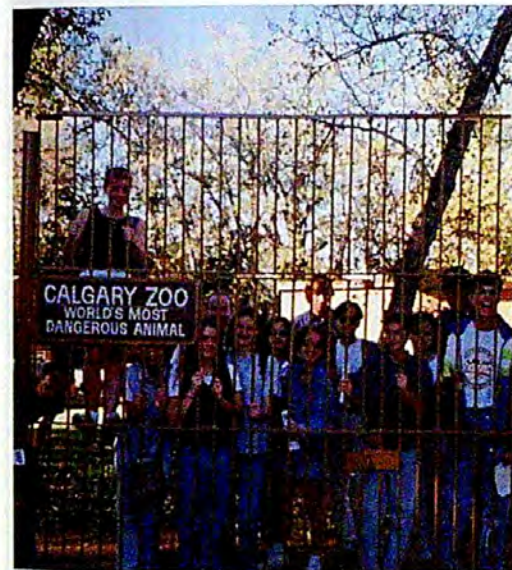
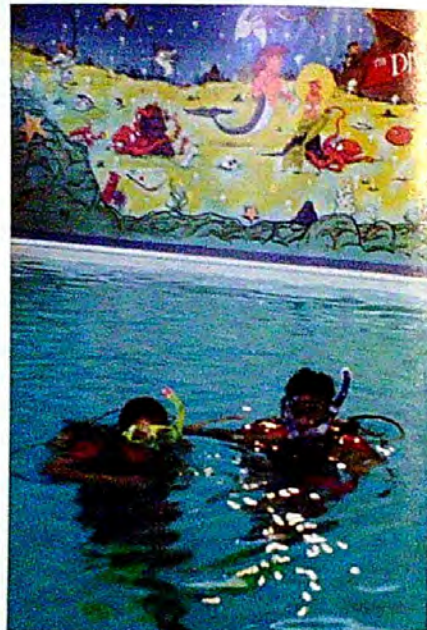
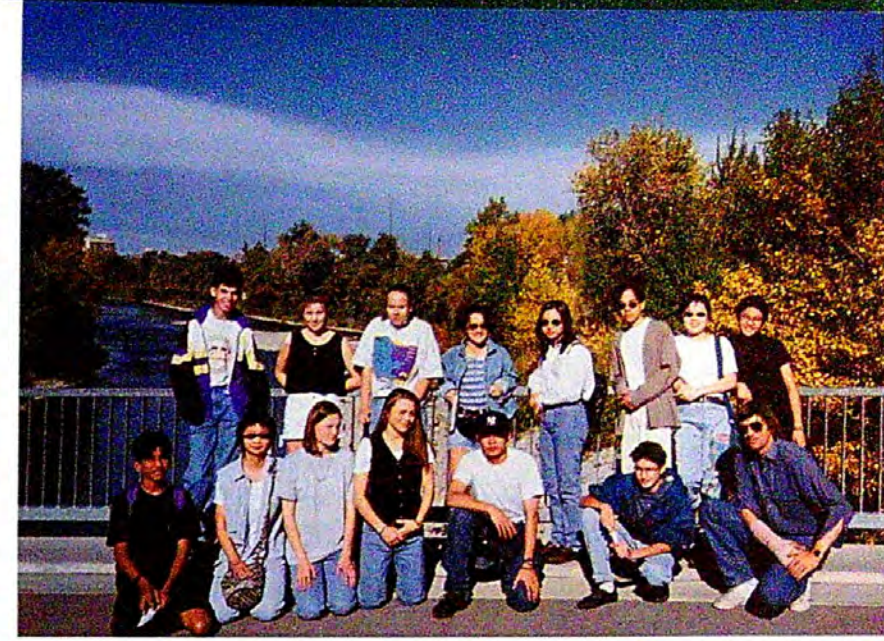

Senior Experiential Education - Calgary

From Western displays at the Glenbow Museum, to recreational activities in the water, on rollerskates, and iceskates, to vantage points and outdoor attractions, the in-Calgary Experiential Education trip offered variety.

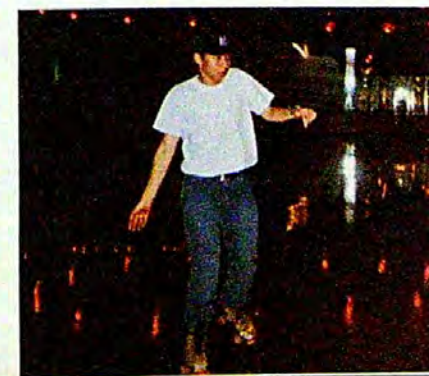

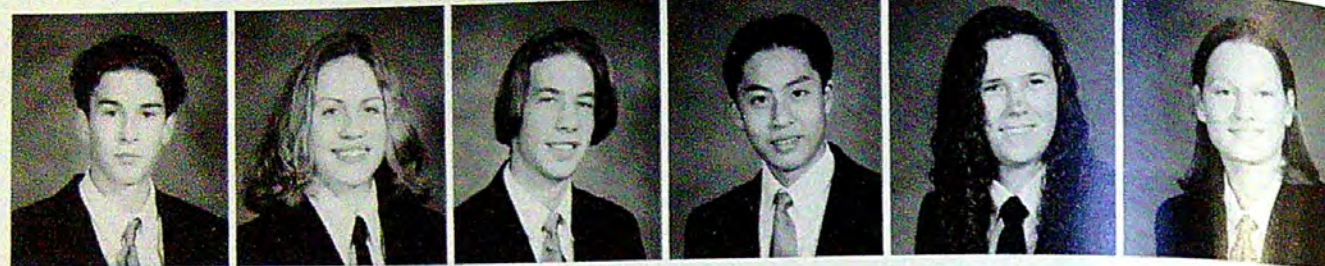

Eli Abergel Sarah Alexander Darcy Carriere Leo Choy Cynthia Churcher Keya Clegg

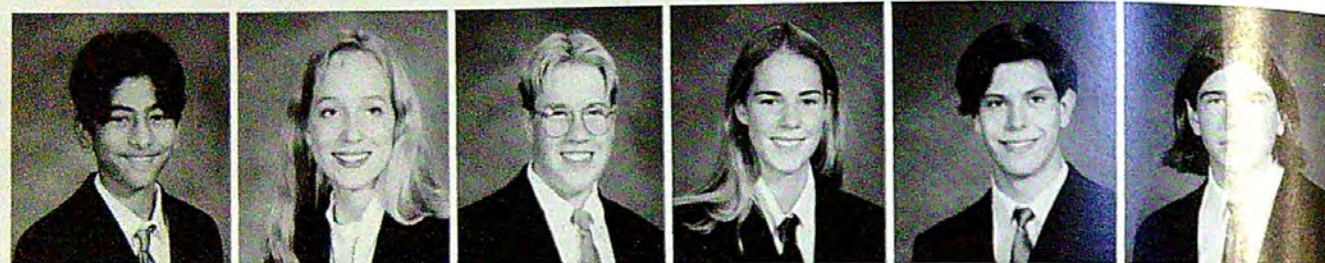

Faisal Dosani Joan Evans David Friesen Kristine Gagnon Kevin Howson Robert Iverach

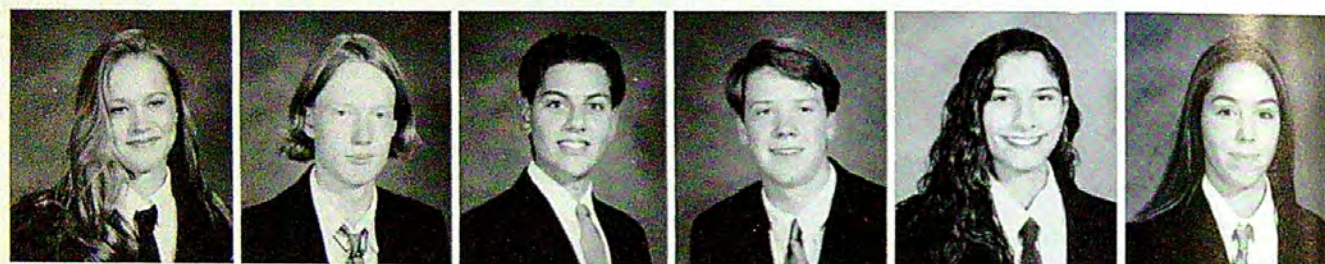

Jennifer Johnson Magnus Keith Billy Koutselas Patrick Loftus Sonia Lota Maya Malik

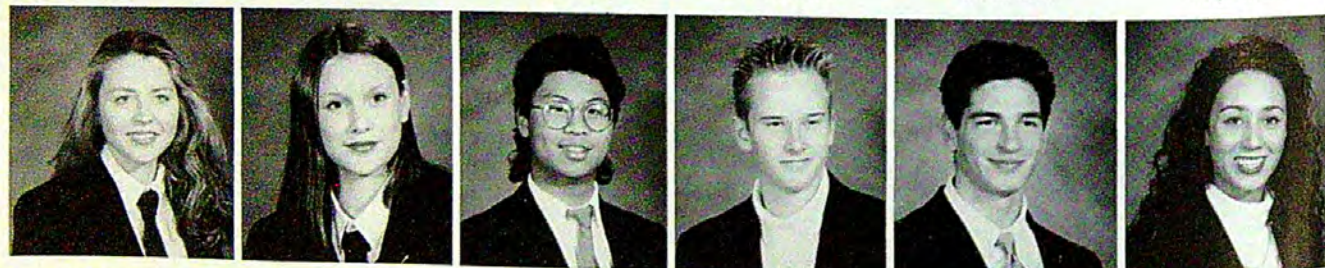

Kelly Murphy Krista Nichol Ian Obligacion Glenn Pickard Kian Rasa Jothy Sanghera



THE GRADE ELEVEN CLASS

All eyes on us

In Grade Eleven, we were proud of the fact that we were easily the most animated class in the school - lots of energy, and we tried to convert it into spirit and enthusiasm, and sometimes we were even successful! Thanks to everyone for a great year.

To the left is one of our number, mad scientist Glenn Pickard about to blow up the Chemistry Room. Perhaps he is just mixing a chemical reaction for some experiment - but the wicked smile on his face seems to tell another story.

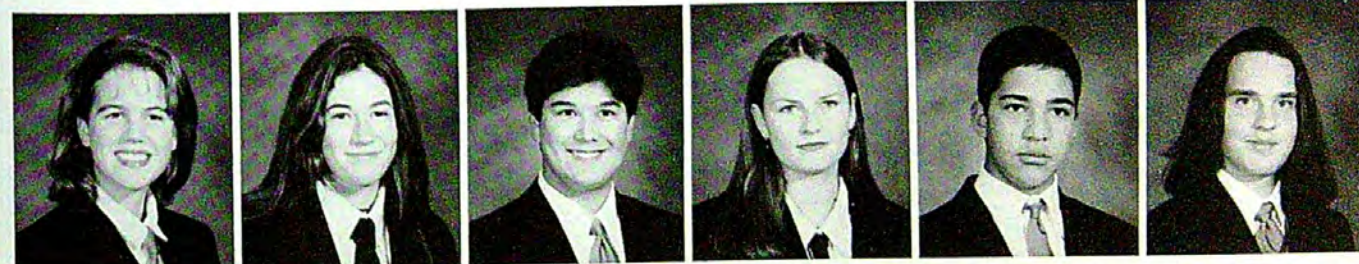

Jessica Schovanek Catherine Sharp Michael Sugimoto Adriana Sztuczka Khaldoun Umar Grant Weisgerber



Bernadette Wong Rachel Wong Patrycia Zapasnik Davis Zentner



Grayson Ambrose

Bye, W.I.C. - nice knowing you! I believe that everyone has their own goals and dreams in their minds; this is another world, a whole new look at life and all its different components, which make up the field you are now able to see through. The meaning of life is almost in your grasp!!! I'll miss you Michelle, Abena, Sonya, and everyone else. Oh ya, Darcy, Cal keep the tradition alive!! Forever.

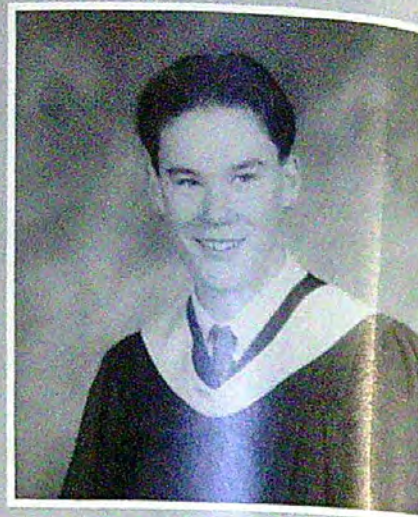

Lianne Barnieh

This is the moment of departure; can't fake it. Thanks to one and all for the good times, you guys were the wind beneath my wings. Good luck, take care and call me. See you all underwater.

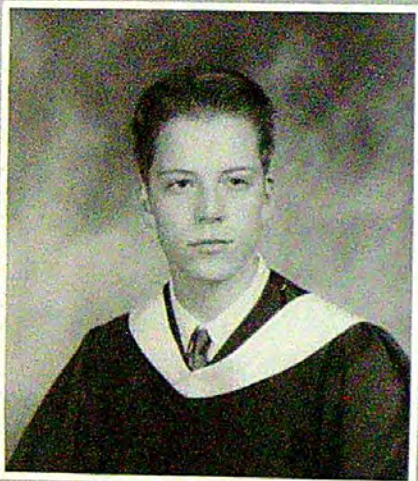

Mark Bauman

When I first came to West Island College in February of this year I was skeptical. I knew that it was a fantastic school but I was anticipating the stereotypical private school attitudes. Yet in a short time I realized how caring, thoughtful, generous and supportive the people at West Island College were. Only one thing stands, Between you and your own goals, It's your will to strive. (Haiku - by Mark Bauman) P.S. Boom!

Abena Boadi

WEST ISLAND COLLEGE! Six years of my life have been filled with funny moments and not so funny moments. I have met the most interesting people who later became my friends and guided me and offered me their help. N.B., K.B. - I hope that we won't have to see those bulging eyes again, and get stuck in the closet. Thanks Mommy and Daddy for supporting and believing in me. M.C., A.S., A.R. - I am a rock, I am an Island!! M.C. - I didn't mean it; please don't think I think that. A.R. - You still owe five bucks. A.H. - Thanks for putting up with me in Math; Don't forget your sweater. C.E. - You win. J.F.B. - I'm still looking for your sleeping bag. J.J.B. - You never told me but I still love you. M.H. - You can be mine. K.L. - We will show them all someday! L.B. - How's Way. T.D. - Don't lose hope; be yourself. I cherish the relationships I have made and I hope they will last forever.

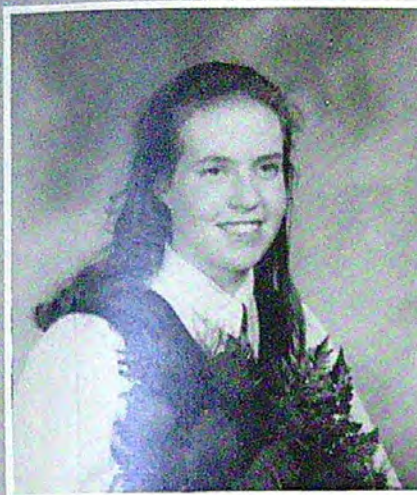

Michelle Chenery

"They who go feel not the pain of parting; it is they who stay behind that suffer" - Henry Wadsworth Longfellow
"You must look into people as well as at them." - Lord Chesterfield
"A moment's insight is sometimes worth a life's experience" - Oliver Wendell Holmes
"Actions are our epochs" - Lord Byron
Life looks good from the driver's seat! Ha Ha B. FLOWER POWER. - Look for me somewhere in Europe. - BYE

Frank Cheung

W.I.C. - a small but great school! I had a lot of fun and gained many experiences during my three years in W.I.C. I want to thank Mr. Rennie who helped me a lot in Social Studies and in applying to universities. Especially, thanks go to Becky Y., Benny N., Bernadette W., Leo C., Winnie W., and Raymond N.

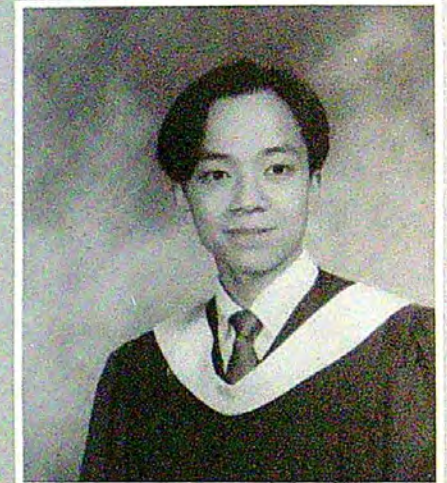

Teresa den Boef

"Here we are all, by day; by night we're hurled by dreams, each one, into a several world." - Robert Herrick (1591-1674)
To all of the grads, I wish you the best of luck with all of your endeavours.

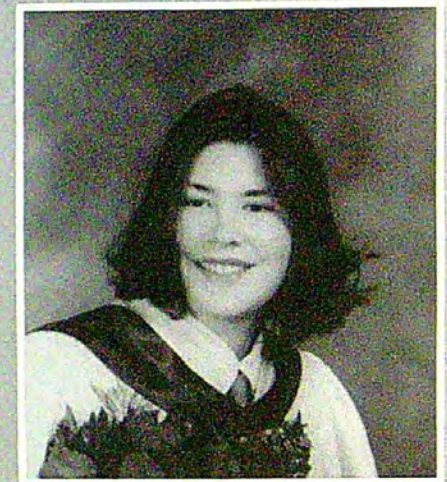

Caroline Elliott

"Let us go then" - T.S. Eliot, "Souls that have toiled, and wrought, and thought with me . . . to seek a newer world" - Alfred Lord Tennyson. "And from below, the sound of a door slamming" - Henrik Tloesen.



Thanks for sending me here Mom and Dad - it's great. I love it. I love my fish.

Wade Elofson

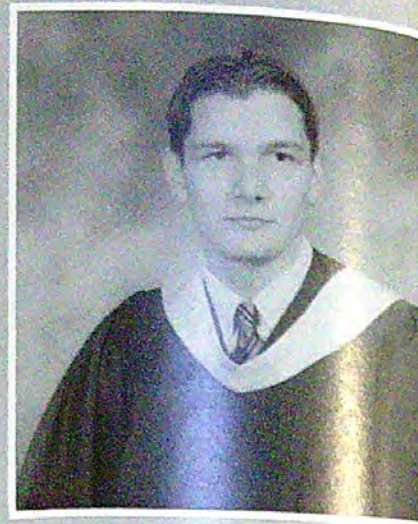

Anita E. Fofie

I always have something to say and yet now that it's over, I'm at a loss for words. Well let's see... Sweeters, Ope, Chia Pet, I've seen and done it all at W.I.C. but there's still so much to learn. Oh well A.R.L.B.: I'm only gonna show you the "running man" once more, if you can't get it after six years then maybe you guys were never meant to groove. A.H., thanks for keeping me on target and C.E. thanks for just being you (temper and all), K.L. we had good times, A.B. what can I say? You and I will be together forever, like parallel lines. Anyway, I'll be brief (English 30 is over, I know Ryan) Peace.

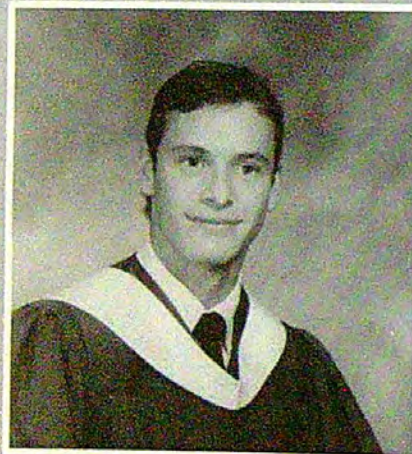

Shaun Ford

"One ship drives east and another drives west with selfsame winds that blow;
It's the set of the sails and not the gales
that tells them where to go.
Like the winds of the sea are the winds of fate,
As we voyage along through life;
It's the set of the soul that decides its goal,
and not the calm or the strife."
Don't lose sight of your goals, and remember "Our greatest glory is not in never failing, but in rising
everytime we fail." S.F. and A.J. rule all.

Jeremy Freeborn

W.I.C. - Well, this is the year to say good-bye or choose a different word from "dominate". Hopefully, I'll be off to Mount Royal College next year. Mase, how many more? Tiny, stay cool. Neil, I need some more stuff photocopied. Matty, go for the gold. Well, it's been a solid three years. Au revoir, Tiny, Mase, Matty, Sims, Al, Neil, Yachney, Lailey, Wade, Ford (congrats again, you're going to make it), A.J., Gray, and Mark. If the Oilers do not win the cup this year, they will win it next year, or at least the year after that!

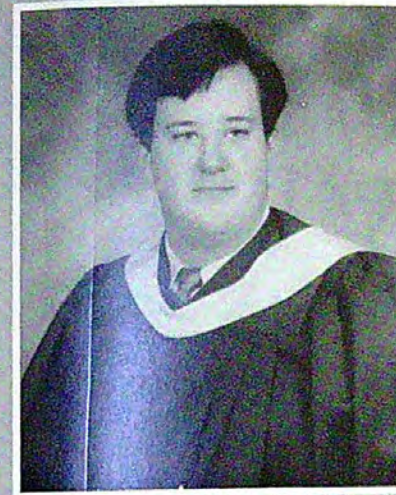
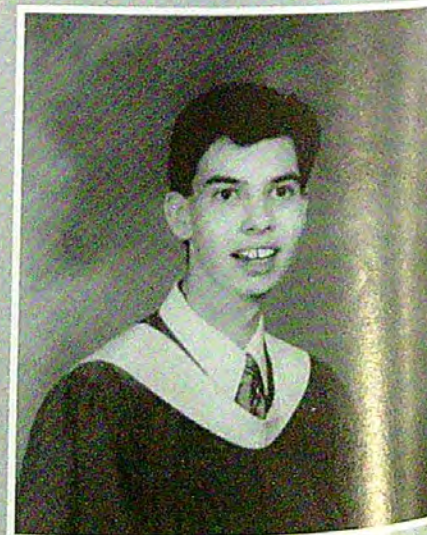

Ryan Glasman

Going to W.I.C. was an adventure. It was a 3 year adventure full of fun and memories. To quote the movie *Total Recall*: "Memories that will last a lifetime." I had many friends at W.I.C. and I will not forget them. To M.M, N.G, G.M, A.J. - To keep your mind full of certain thoughts - just remember the old woman joke. See you around.

Tiny

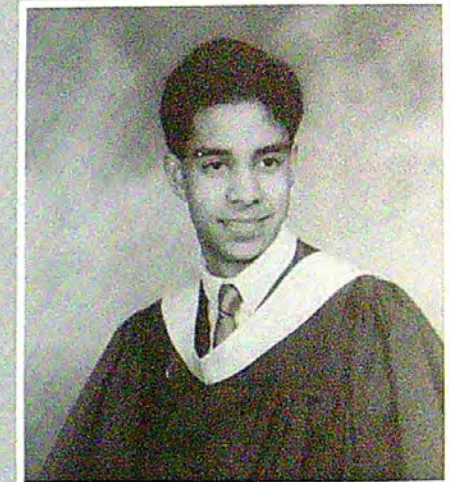

Neil Gohill

Well it's finally over. We all made it through our years at W.I.C. I'd like to say thanks to all the teachers and students for a great three years. R.G. - keep on drinking milkshakes. 3-2-1 Mace - retake drivers education and learn how to drive a car. - M.M. - thanks for all the jokes which made our classes go by quicker. A.J. - try to keep your New Year's Resolution. S.G. - don't conform with society. J.F. - get a new sports team. RL, WE, MC, AS, KL, AB, FC, BN, AM, GA - I hope that you all are successful in life.

Simon Goodspeed

Over the years I have angered people, and made people shake their heads. Being here since grade 7 has made me find who I was. One of the hardest lessons I've learned is to be true to yourself; do what you want, live the way you want to live. Now I know some people may not like me; that's cool, I don't like them either. So I end up with the following quotes. "I can take Responsibility for what I've done, but not for who I am." - NOFX. "Rock hard, Ride Free." - J.P. "I may be dumb but I aint dead." - Super S. I almost forgot; skiers are lame. Ride forever.

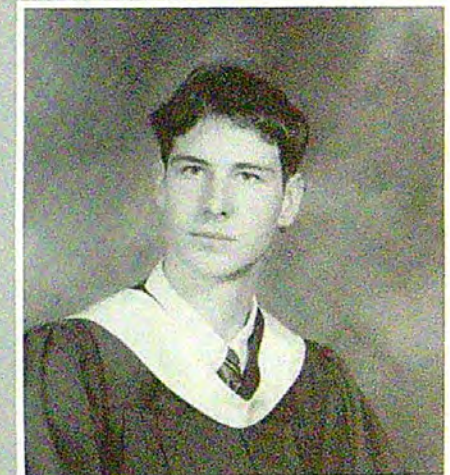

Andrea Thera Hamel

"I am the real thing"
Crush with eyeliner - by R.E.M.
Thank you W.I.C. for giving me the chance to be myself, for allowing me to let the real me shine through. And thanks to all the people who were there for me during my six years here and who made this time so special. THANKX, you know who you are...
Grade nine flashback -
"Hey Hey we're the Monkees!"
by (of course) the Monkees

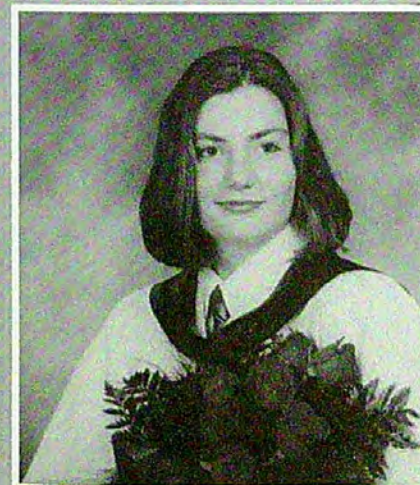

"Each is given a bag of tools,
A shapeless mass,
A book of rules;
And each must make,
Ere life is a flown,
A stumbling block
or a stepping stone."

R.L. Sharpe

Well guys, you're in the driver's seat now, just try to stay on the road. A.B., mustard is gross (sorry about the hot chocolate). Thanxs teachers (Mr. Poitras aussi!), thanx friends, keep in touch (not physically, of course, I just don't want to.) K.L., don't worry, I still like you. C.E., no more violence!

M.B., you make the view better. A.H., get a wash for your sweater.

- Megan P.S. Mormons are cool.

Megan Hatch



Andrew Jennens

I'm out of here! Well boys we made it! I'm going to the Ranchmans! "I'm gonna live forever if the god die young" - Tracy Lawrence. "If we'd known ten years ago ten years would be today, would we spend tomorrow's yesterdays or make it last somehow" - Clint Black. Matty, Tiny, Mas, N.G., S.E., S.Y., R.L., and ever you Jerbo take it easy. S.G., W.E. you guys are weird man. L.B. - one day I will teach you how to step

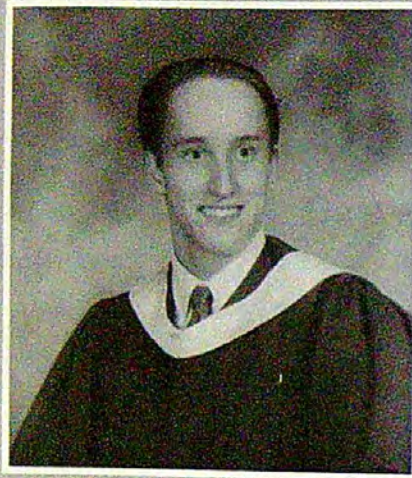

Ryan Lailey

It's hard to believe that it's all over! We're at the crux of the matter now! I had a great time here at W.I.C. See ya A.J., M.M., G.M., tiny, S.G., W.E., S.F., S.Y., D.C., snotty M., T.F., F.G. and A.M. Long live the S. I can't believe this all equals to one!

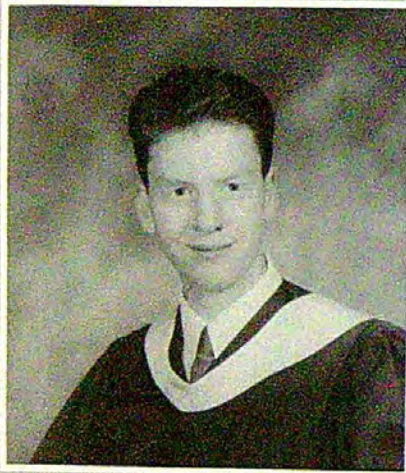

Kim Linder

"The road to success
has many directions
only we can create the
colourful dimensions.
So now it is time,
the moment's at hand,
doubt and fear
have both been banned!"

C.E. - You are the most successful procrastinator that I have ever met. Don't let university change that! A.H. - I don't know how I got the answer, but I got it! A.B. You are my partner in height. DON'T GROW! A.F. - The law is still on our side. M.H. - Don't worry I still like you! Peer Support - We don't gossip, we discuss!!! To the entire graduating class - Good Luck and Best Wishes!



Matty McLeod

All good things must come to an end; if you can call them good! The things that I will remember the most are A.J.'s bumper, 1-2-3 mas and the famous "hoopshot". I have changed a lot at WIC, going from a nothing to a beaky, happy McLeod. Everyone take care and I will never forget any of you. (Especially you, Ada). But before I go, I'll leave you with a question once asked by Jerry Sienfield, "What is the handicapped parking situation at the Special Olympics?"

Alim Mawji

It's finally over!!! My six years at W.I.C. have flown by. I've made many friends at W.I.C. that will last me a lifetime. Forget the initials; everyone that I've encountered at W.I.C. has meant something. W.I.C. will be an experience that I will never forget. May everyone have success in their future endeavours. Remember SHAO Rules!!! Peace. 786.

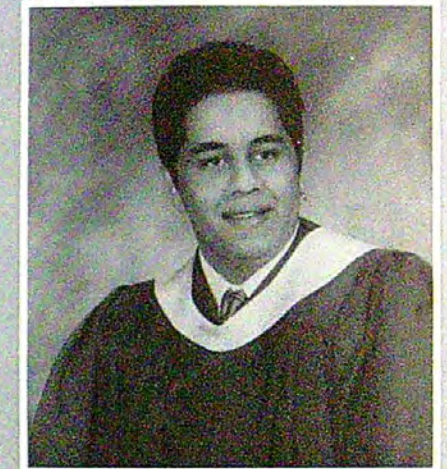

Geoffrey Mason

Well we finally made it! Look who is laughing now fat man (Mac)! M.M. don't lose the beak. A.J. the truck won't be as fun as the Merc. Neil reach for the Giraffe. Hey J.F. those Oilers suck. Long Live G.G.T.W. one and two. Whit Woo!!! RL, SF, WE, MC, GA, SY, DC, AS, SG, and KG its been fun! B-BYE!

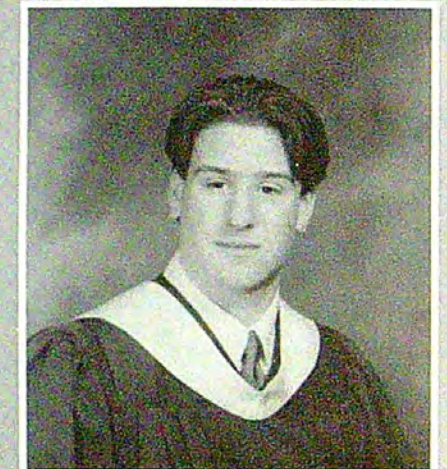

Benny Ng

I have only been at W.I.C. for three years, but it gave me a good opportunity to widen my view and become a more independent person. Being a foreign student at W.I.C. is a wonderful experience. I will never forget it! My teachers and my classmates were very patient with me and helped me overcome many obstacles.

Special thanks to: Mrs. McGee
Mr. McClintock
Mrs. Morin
Mrs. Bedard
Mr. Rennie
RN, FC, BY, BW, TD, NG

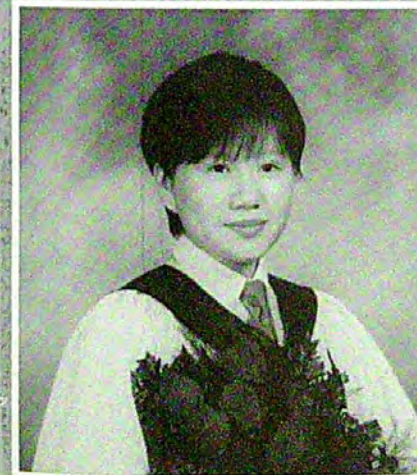

Andrea Remington

"Life is like a tale told by an idiot; Full of sound and fury, signifying nothing." Oh Henries, Circle K coffee, you can run but you can't hide . . . Midafternoon, on a hill outside - bring ice cubes. Bye. AR/95



Becky Yim

I enjoyed spending these two years at W.I.C.. And I have learned many things during these years. I would like to thank Frank C., Raymond N., Benny N., Bernadette W., Winnie W., and Leo C., for all of their help.



Julianne Reti

Even though I've only been at W.I.C. for one year, I've had many experiences. I met a lot of new people which was really great. I'm so glad that high school is over and I'm looking forward to trying new things!



Amy Skinner

"If you can't change the world . . . then change yourself. If you can't change yourself . . . then change the world." Coffee, Oh Henries and homework make the world go round, but only silk sheets and travelling will get me through. Thanks Rem for always being there, and thanks to everyone else for putting up with me.

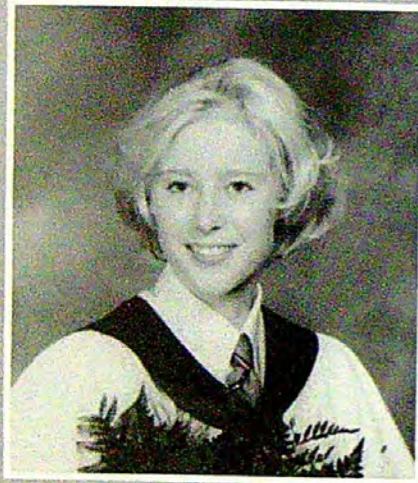

Steven Yachney

I will always remember the good and bad times of W.I.C.. All the times I was up to 1 a.m. doing homework, etc. Well I would just like to say goodbye to all the people. B-Bye! Have another good year Darc; I know your looking forward to it. P.S. Bruins Rule!

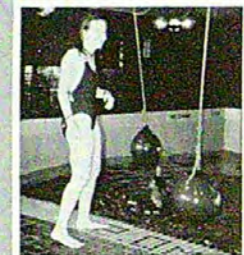
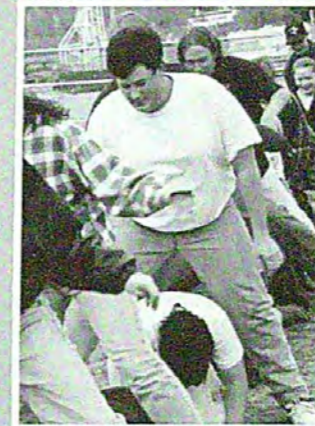
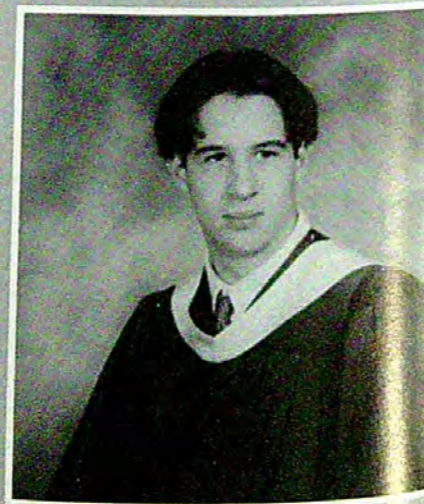

Class of 95

Commencement Exercises
June 16



West Island College
Commencement Exercises
June 16, 1995



- Processional
- @ Canada
- Welcome
- President - Founder's Address
- Chairman of the Board of Governors' Address
- Presentation of Graduation Diplomas
- Presentation of Awards of Distinction
- Valedictory Address
- Benediction
- Recessional
- A. Hamel
- T. Grant
- S. Davies
- F. Bercha
- S. D. Davies
- F. Bercha
- H. Renne
- Faculty
- A. Fofie
- A. Bedard



Graduate Major Award Winners

- French Language Arts Award: Anita Fofie
- Creative Writing Award: Anita Fofie
- Davies Shield: Jeremy Freeborn
- Hildt Shield: Amy Skinner
- Jane McCoy Shield: Caroline Elliott
- Payne Shield: Benny Ng
- Bejar Shield: Neil Gohill
- J.A. Grant Shield: Kim Linder
- Board of Governor's Award: Amy Skinner
- A.J. Grant Shield & Board of Governor's Medallion: Andrea Hamel

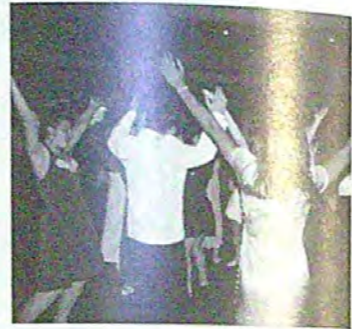
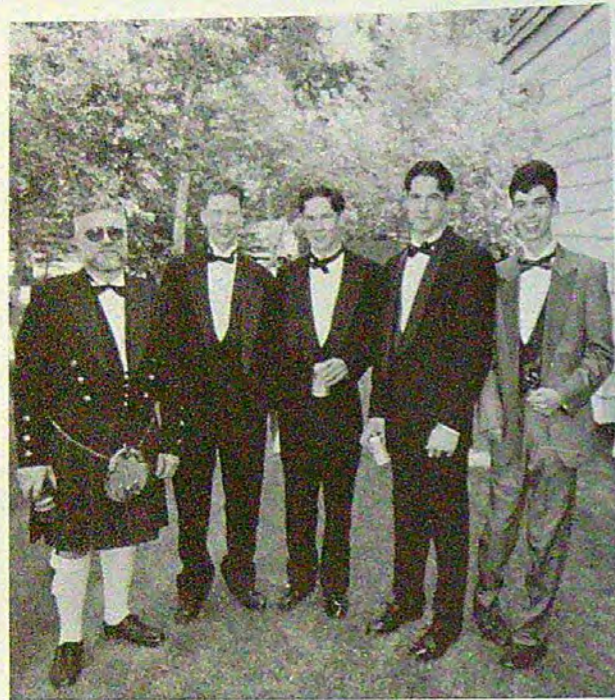

Graduate Dinner and Dance

Following the ceremonies pictured on the previous pages at the Glencoe Club on Friday, June 16th, there was a reception graciously hosted by the Boadi family. All of this was followed on Saturday, June 17th, 1995, with a pre-dinner gathering hosted by the MacLeod family, and a dinner and dance at the Petroleum Club in downtown Calgary. Lianne Barnieh and Simon Goodspeed gave a brief toast to the Class of '95, recognizing each student with a humorous award; the rest of the evening is described by the pictures on these pages.



S

P

O

R

T

S



Junior Girls Volleyball

(LEFT TO RIGHT) TOP ROW: Mrs. Gillies, Lara Patterson, Mikyla Conway, Gillian Garrett, Jennifer Graas BOTTOM ROW: Christy Skinner, Jill Marcotte, Nicole Cordeau, Katie Winters, Jenn Lester.



Junior Boys Volleyball

(LEFT TO RIGHT): Assistant Coach - Mrs. Bedard, John Owens, Chris Radulsky, Dave Watson, Chris Murdoch, Connor James, Neil MacBeath, Austin Fraser, Callum Paterson, Mike Lobsinger, Dave Loftus, and Parker Mason. ABSENT: B.J. Herchuk, Jared Leboldus, Mike Bedard (Coach)



Senior Girls Volleyball

(LEFT TO RIGHT) FRONT ROW: Breanne Thomlison, Shannon James, Rehana Allidina, Andrea Remington, Amy Skinner, Caroline Elliott BACK ROW: Abena Boadi, Chantelle Styles, Kristine Gagnon, Maya Malik, Megan Hatch, Mr. Poitras (Coach) ABSENT: Kira Horsfall, Julianne Reti, Jessica Schovaneck.



Senior Boys Volleyball Team

(LEFT TO RIGHT) TOP ROW: Mr. Chalifoux, Kevin Howson, Pat Loftus, Geoff Mason, Kian Rasa BOTTOM ROW: Jeff Lane, William Bercha, Andrew Mayer, Jay Banister, Stephan Gagnon ABSENT: Quinn Griesdale, Chris Forrest.

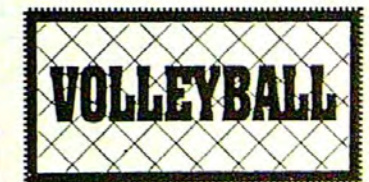

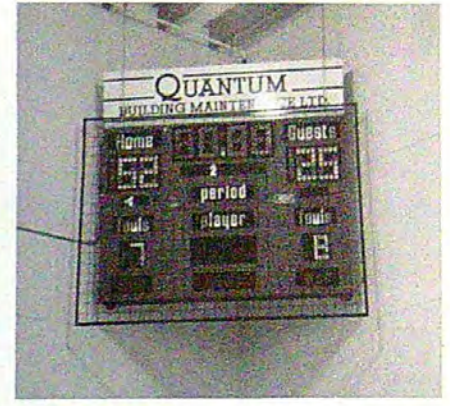
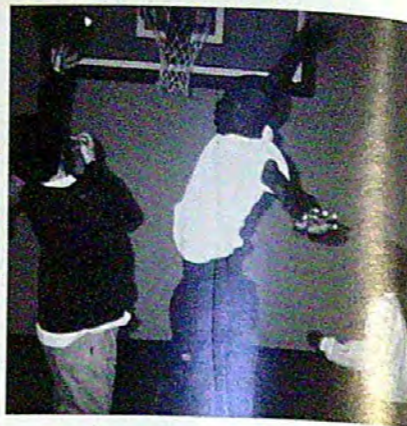
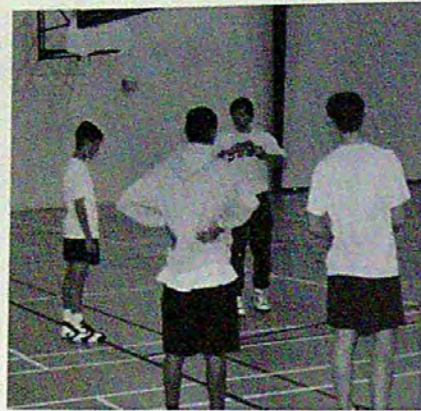

Junior Girls Basketball Team

LEFT TO RIGHT: BACK ROW: Mr. Forrester (Coach), Jill Ewens, Julia Bouvry, Erin Lester, Adriana Jamniczky, FRONT ROW: Laura Grant, Loraine Lau, Emily Mackie, Jacqueline David, Alana Gillean, Nicole Cordeau, Jennifer Lester ABSENT: Delphine Bouvry, Courtney Biggs (Coaches)



Junior Boys Basketball Team

(LEFT TO RIGHT) TOP ROW: Mr. Smith (Coach), John Olson, John McGee, Davin Henson, Ali Kellough, Mike Jarrell, Mac Homme, Marshall Wigham FRONT ROW: Christopher Radulski, Kwasi Boadi, Craig Huber, Connor James, David Loftus, Kyle Chipman, Austin Fraser



Senior Girls Basketball

(LEFT TO RIGHT) FRONT ROW: Joan Evans, Adriana Hunstad, Maya Malik, ISAA Championship Trophy, Shannon James, Amy Skinner, Andrea Remington BACK ROW: Mrs. Gillies (Coach), Christina Reti, Heather Jamniczky, Kristine Gagnon, Chantelle Styles, Catherine Sharp, Megan Hatch, Mrs. Whitehead (Coach) ABSENT: Kira Horstall



Senior Boys Basketball

(LEFT TO RIGHT) FRONT ROW: Brendan McLeod, Jay Banister, Andrew Mayer, Stephan Gagnon, Faisal Dosani, Kian Rasa SECOND ROW: Pat Loftus, Geoff Mason, Kevin Howson ABSENT: Brian Haynes and Carolyn Decock (Coaches)



Floor Hockey



Junior Boys Floor Hockey Team (First Semester)

(LEFT TO RIGHT) FRONT ROW: Jonathan Glass, Connor James, Callum Patterson, David Loftus, David Watson. BACK ROW: Andrew Mayer (Co-Coach), Kent Swanlund, Jonathan Owens, Chris Radulski, Mike Lobsinger, Amish Patel, Stefan Gagnon (Co-Coach).

Junior Boys Floor Hockey Team (Second Semester)

(LEFT TO RIGHT) FRONT ROW: Jeff Johnson, Connor James, Callum Patterson, David Watson, Jason Whitney. BACK ROW: Bruce Urquhart, Jonathan Owens, Shane Hare, Chris Radulski, Mike Lobsinger, Mr. McClintock (Coach).

Senior Boys Floor Hockey Grade Ten Team

(LEFT TO RIGHT) FRONT ROW: William Bercha, Andrew Mayer, Jay Banister, Stephan Gagnon, Nick Zikopoulos. BACK ROW: Matt Youens, Garrick McIntosh, Brendan McLeod, Nick Livaditis, Mr. McClintock (Coach).

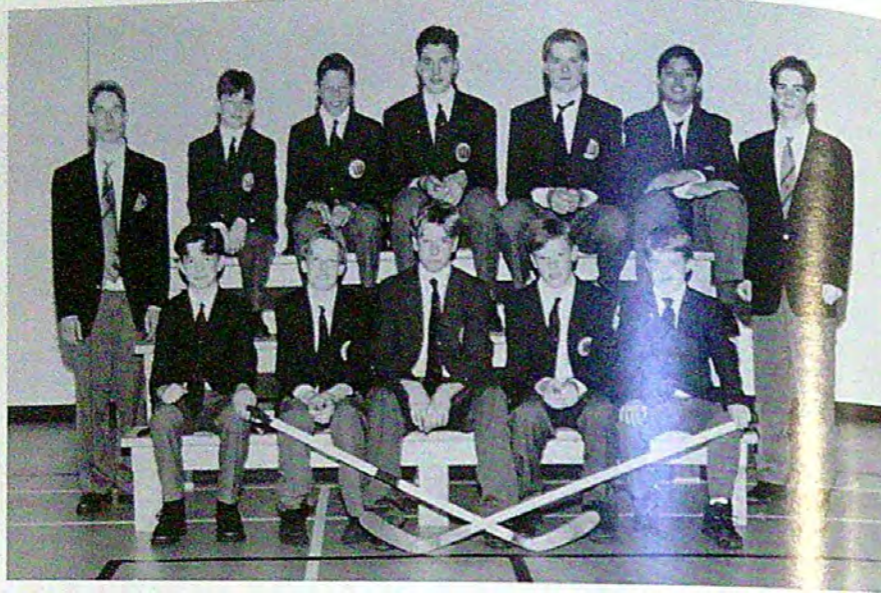

Senior Girls Floor Hockey
(LEFT TO RIGHT) FRONT ROW: Jothy Sanghera, Jennifer Johnson, Maya Malik, Kira Horsfall, Kathy Tinline, Erika Lobsinger. BACK ROW: Michelle Chenery, Catherine Sharp, Kristine Gagnon, Joan Evans, Rehana Allidina, Heather Jamniczky, Mrs. Whitehead (Coach)



Senior Boys Floor Hockey Team

(LEFT TO RIGHT) FRONT ROW: Geoff Mason, Grayson Ambrose, ISAA Championship Trophy, Andrew Jennens, Ryan Glasman. BACK ROW: Darcy Carriere, Steve Yachney, David Uniacke, Alim Mawji, Ryan Lailley, Mr. Rennie (Coach). ABSENT: Matt MacLeod



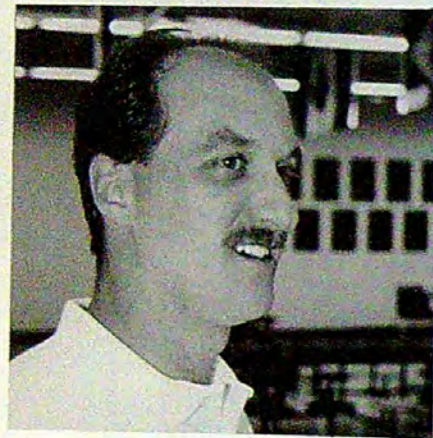
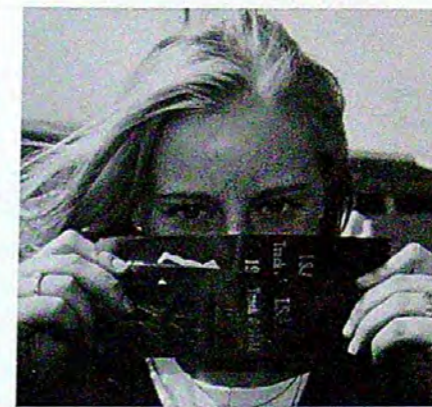

Junior Badminton

(LEFT TO RIGHT) FRONT ROW: Kent Swanlund, Julia Bouvry, Erin Lester, Jen Waslen, Nicole Cordau, Jacqueline David, Alana Gillean, David Watson, Eric Grochowski. SECOND ROW: Lorraine Lau, Fady Girgis, Christy Skinner, Lauren Wigham, Emily Mackie, Karly Denoon, Carly Bindman, Laura McKinnon, Daniel Stoffman. THIRD ROW: William Devlin, Jonathan Glass, Jill Ewens, B.J. Herchuk, Andrew Dickie, Andrew Keeping, Mikyla Conway, Lara Patterson, Mr. Chalifoux. FOURTH ROW: Jared LeBoldus, Jennifer Lester, Callum Patterson, Connor James, McDonald Homme, David Loftus. LAST ROW: John Olson, Stephen Jakubec, Austin Fraser, Craig Goldie, Sameer Mawji. ABSENT: Alex Sabey.

Sr. Badminton

(LEFT TO RIGHT, TOP TO BOTTOM): Patrick Loftus, Grant Weisgerber, Matthew Youens, Rehana Allidina, Heather Janniczky, Maya Malik, Nick Livaditis, Chantelle Styles, Mr. Chalifoux, Shannon James, Kathy Tinline, William Bercha, Andrew Mayer, Stephan Gagnon, Mark Payne, Ian Obligation and Jeff Lane. ABSENT: Kira Horstfall.



Junior Track and Field

(LEFT TO RIGHT) FRONT ROW: Connor James, David Watson, Nicole Cordau, Jacqueline David. SECOND ROW: Jeff Johnson, Fady Girgis, Kent Swanlund, Kate Elliott, Jennifer Waslen, Alana Gillean, Tasha O'Connor, Katherine Winters. THIRD ROW: Laura Tinline, Christy Skinner, John Olson, Craig Huber, Kwasi Boadi, Jennifer Lester, Gillian Garrett, Vanessa Hara, Mr. Chalifoux (coach). FOURTH ROW: Mr. Smith (coach), Jill Marcotte, Mikyla Conway, Michael Lobsinger, Joseph Everett, Andrew Keeping, Erik Scheel, Mr. Poltras (coach). TOP ROW: Mrs. Gillies (coach), Morgan MacGregor, Daniel Gillean, Austin Fraser, Callum Patterson, Julia Bouvry, Ms. Breland (coach). ABSENT: Laurel Alexander, Michelle Iverach, James Holder, Peter Fuerbringer (Assistant Coaches)

Senior Track and Field

(LEFT TO RIGHT) FRONT ROW: Thomas Ferianec, Stephan Gagnon, Andrew Mayer, Ian Obligation. SECOND ROW: Mr. Smith (Coach), Jennifer Johnson, Kira Horstfall, Natalie Stanhope, Breanne Thomlison, Abena Boadi, Kathy Tinline, Rehana Allidina, Adriana Sztuczka, Mr. Chalifoux (Coach). THIRD ROW: Mrs. Gillies (Coach), Jennifer Keeffe, Christina Reti, Kristine Gagnon, Chantelle Styles, Shannon James, Amy Skinner, Ms. Breland (Coach). FOURTH ROW: Jay Banister, Garrick McIntosh, Kevin Howson, Brendan McLeod, Mike Sugimoto, Dave Unlacke, Mr. Poltras (Coach). ABSENT: Anita Fofie, Kian Rasa, James Holder, Peter Fuerbringer (Assistant Coaches)



Ski Day!

On February 3rd, 1995, West Island College once again took to the slopes on our annual Ski Day. Lake Louise was the destination, both for downhill skiers and for those who chose cross-country up around the Chateau and Lake Louise itself. Snow conditions were good, the temperature was perfect and there was even some sun on a mostly overcast day. These pictures show some of the highlights.

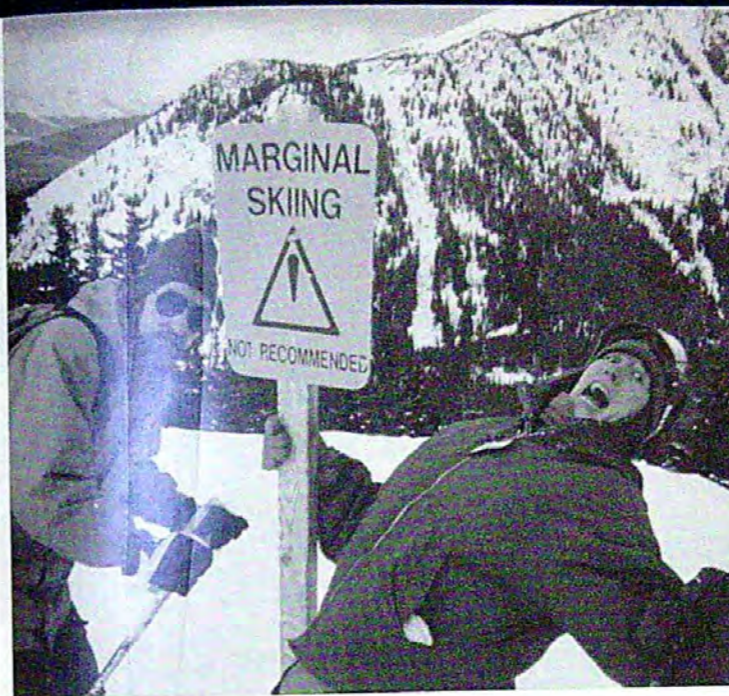

W.I.C.A.A. Awards Evening

Hosted by the West Island College Athletic Association: President - Amy Skinner; Executive - Kim Linder, Josee Pilon, Adriana Hunstad, Neil Gohill, Maya Malik, Adriana Sztuka, Teresa den Boef, Abena Boadi, Andrea Remington, Kian Rasa, Kira Horsfall, Kristine Gagnon, and Heather Jamniczky; Staff Advisor - Mr. McClintock.



MOST VALUABLE PLAYER AWARD WINNERS BY TEAM, INTRAMURAL GUY SMILE AWARD WINNERS BY HOUSE, TOP ATHLETES OF THE YEAR, AND THE 1994-1996 WICAA COUNCIL

Most Valuable Players by Team:
 Junior Girls Volleyball: Christy Skinner
 Junior Boys Volleyball: Austin Fraser
 Senior Girls Volleyball: Chantelle Styles
 Senior Boys Volleyball: Kian Rasa
 Junior Girls Basketball: Jen Lester
 Junior Boys Basketball: Ali Kellough
 Senior Girls Basketball: Heather Jamniczky
 Senior Boys Basketball: Brendan McLeod
 Junior Boys Floor Hockey (1st sem.): Callum Patterson
 Junior Boys Floor Hockey (2nd sem.): David Watson
 Senior Girls Floor Hockey: Heather Jamniczky
 Senior Boys Floor Hockey (Team 2): Nick Livaditis
 Senior Boys Floor Hockey (Team 1): Steve Yachney
 Junior Girls Badminton: Nadia Barnieh
 Junior Boys Badminton: Mac Homme
 Senior Girls Badminton: Maya Malik
 Senior Boys Badminton: William Bercha
 Junior Girls Track and Field: Julia Bouvry
 Junior Boys Track and Field: Callum Patterson
 Senior Girls Track and Field: Anita Fofie
 Senior Boys Track and Field: Kevin Howson

Intramural/Guy Smile Awards:
 Bedard House: Stephan Gagnon
 Loughheed House: Conor James
 Fox House: David Watson
 McDougall House: William Bercha

Top Athletes of the Year:
 Junior Girls: Jen Lester
 Junior Boys: Cal Patterson
 Senior Girls: Maya Malik
 Senior Boys: Kevin Howson

WICAA Council for 1995-96:
House Captains:
 Loughheed - Catherine Sharp
 Fox - Maya Malik
 Bedard - Sonia Lota
 McDougall - Jennifer Johnson

Assistant House Captains:
 Loughheed - Adriana Hunstad
 Bedard - Kira Horsfall
 Fox - Matt Youens
 McDougall - William Bercha

Junior House Captains:
 Loughheed - Morgan McGregor
 Bedard - Jill Marcotte
 Fox - Erin Lester
 McDougall - Jeff Johnson

WICAA President for 1995-96: Kevin Howson

On June 7th, the Annual WICAA Awards Evening took place at the school. Amy Skinner and Kim Linder welcomed to WIC all in attendance, gave an overview of WICAA and the past year, and then allowed other members of WICAA to introduce various sports and call upon the coaches to present their most valuable player awards, most of which are shown in pictures on these pages. Teams that won major ISAA Trophies were recognized and are also shown here. A slide show and video presentation provided visual effects for the evening, and the evening closed with the Top Athletes of the Year Awards, handed out by incoming WICAA Staff Advisors Mrs. Gillies and Mr. Chalifoux. Then next year's elected WICAA council was introduced and special presentations were made to first semester WICAA co-Advisor, Kim Ormrod, and to outgoing WICAA Advisor Mr. McClintock.



GILLES

Spanish Club

(LEFT TO RIGHT) FRONT ROW: M. Bouchard (Staff Advisor), Claudia Haas, Stacey Soutiere, Chantelle Styles, Nicole Raymaker, Laura Voszler, Elizabeth Keith BACK ROW: Teresa den Boef, Christina Reti, Abena Boadi, Mark Mjeda, Lorraine Lau, Andrew Keeping ABSENT: Anita Fufie.



Newspaper Club

(LEFT TO RIGHT) FRONT ROW: Ms. Webb-Briscoe (Staff Advisor), Adriana Jaminczky, Valerie Obligation, Jennifer Waslen, Morgan McGregor, Kate Elliott. BACK ROW: Eric Grochowski, Adam Spragins, Gillian Garrett, Jennifer Graas, Daniel Stoffman. ABSENT: Laura Grant, Craig Goldie



Service Club

(LEFT TO RIGHT) FRONT ROW: Andrea Elmore, Vanessa Jacobs, Caitlin Moore, Elizabeth Klaiber, Jessica Park. TOP ROW: Lara Patterson, Michael Anderson, David Friesen, Kevin Howson.



Choir

(LEFT TO RIGHT) FRONT ROW: Adriana Jamnicky, Andrea Elmore, Vanessa Hare, Chantelle Styles, Nicole Raymaker, Jennifer Steer, Elizabeth Keith. BACK ROW: Mrs. Bedard, Christina Reti, Joan Evans, Gillian Garrett, M. Flottat.



Chess Club

(LEFT TO RIGHT) FRONT ROW: Eric Scheel, Jason Whitney, Shaun Ford, Bruce Urquhart, Aksel Nielsen BACK ROW: Neil MacBeath, B.J. Herchuk, Mark Bauman, Parker Mason, Andrew Keeping



Senior Cheerleaders

(LEFT TO RIGHT): Maya Malik, Kelly Murphy, Jennifer Keefe, Catherine Sharp, Abena Boadi. ABSENT: Anita Fofie



Scorekeepers Club

(LEFT TO RIGHT) FRONT ROW: Valerie Obligation, Kira Horstall, Abena Boadi, Jothly Sanghera, Shannon James, Christina Reti, Breanne Thomlison BACK ROW: John Olson, Kian Rasa, Joseph Everett, Kent Swanlund, Faisal Dosani, Mr. McClintock (Advisor)

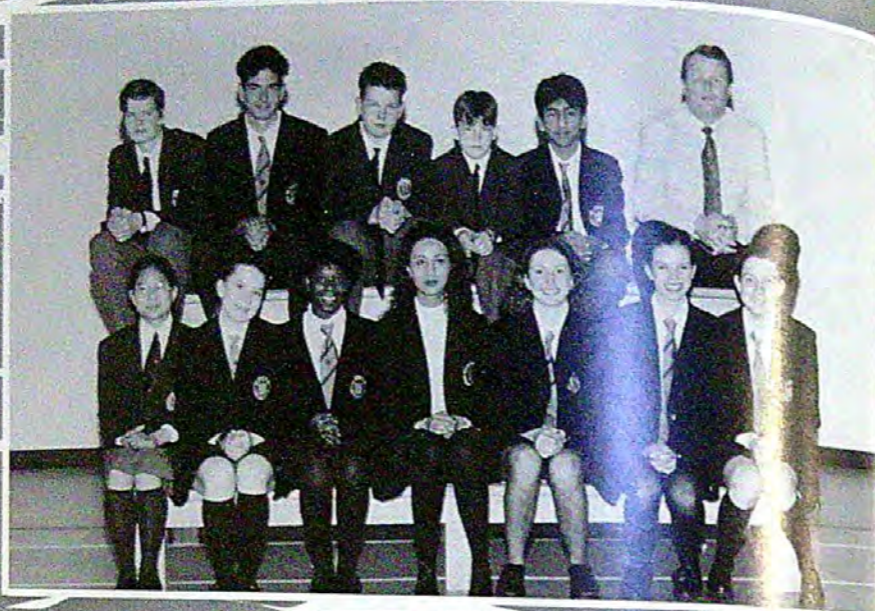

Drama Club

(LEFT TO RIGHT) LYING: Jacqueline David, Katherine Winters, Alana Gillean FRONT ROW: Caitlin Moore, Elizabeth Klaiber, Elizabeth Keith, Nicole Raymaker SECOND ROW: (seated) Lauren Wigham, Carly Bindman, Laura McKinnon, Morgan McGregor, Stephanie Keefe, Jennifer Keefe THIRD ROW: (including standing) Ian Obligation, William Bercha, Matthew Youens, Natalie Stanhope, Michael Sugimoto, Mark Payne BACK ROW: Ms. Webb-Briscoe (Staff Advisor)



Junior Cheerleaders

(LEFT TO RIGHT): Vanessa Hare, Andrea Elmore, Caitlin Moore, Patricia Zapasnik (Senior Student Advisor), Elizabeth Klaiber, Andrea Habermeyer.



Peer Support

(LEFT TO RIGHT, TOP TO BOTTOM): Amish Patel, Dennis Lambert, Craig Goldie, Michael Sugimoto, Desiree Fofie, Mrs. Webb-Briscoe, Kim Linder, Andrea Elmore, Natalie Stanhope, Josee Pilon, Kelly Murphy and Lorie Markowsky, MISSING: Monica Fofie, Anita Fofie, Sonia Lota.



Junior and Senior Debate Club

(LEFT TO RIGHT): FRONT ROW: Maya Malik, Valerie Obligation, Jonathan Kelly, Akxel Nielsen, Caitlin Moore, Elizabeth Klaiber BACK ROW: Mr. Forrester and Mrs. McGee (Staff Advisors), Bruce Urquhart, David Hofer, Neil MacBeath, Erik Scheel, Chris Murdoch, Andrew Keeping, Laura Grant, Kian Rasa, Jothly Sanghera



Outdoors Club

(LEFT TO RIGHT) FRONT ROW: Kristine Gagnon, Abena Boadi, Andrew Mayer, Kira Horstall SECOND ROW: Kathy Tinline, Shannon James, Breanne Thomlison, Megan Hatch, Amy Skinner, Nathalie Stanhope, Christina Reti THIRD ROW: Andrea Hamel, Maya Malik, Rehana Allidina, Michelle Chenery, Catherine Sharp, Nick Livaditis, Mr. Poitras (Advisor) ADVISORS ABSENT: Ms. Morin, Mr. Smith

THE ART AND LITERATURE SECTION

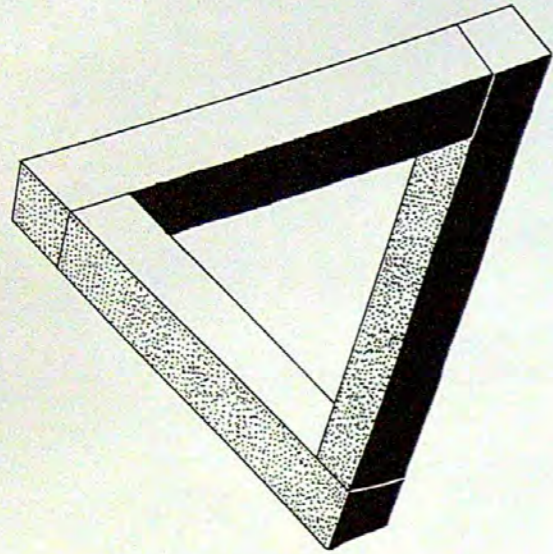

English and Art Programs

Here is some creativity at work, both in terms of writing and art. The next eight pages are filled with art and different forms of creative writing. This page leads the section with Mr. Parnell pictured to the right, dressed for Open House. Above this text is a drawing by Rachel Wong, a Grade 11 student who is also pictured with her sketchbook in the bottom right. Below are other Grade 11 art students at work.

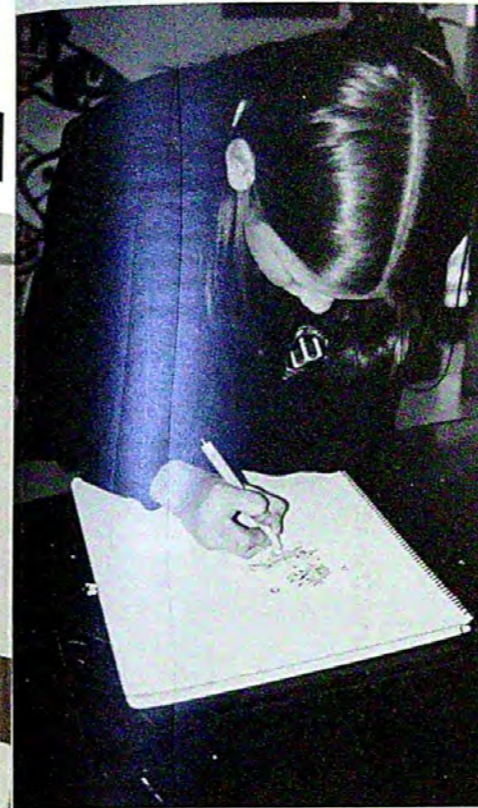

Krista Nicol is at work to the left; Grade 9 watercolor drawing is pictured above and below, and the bottom of the page shows a picture of Ian Obligacion working on a drawing next to the final version of his work.

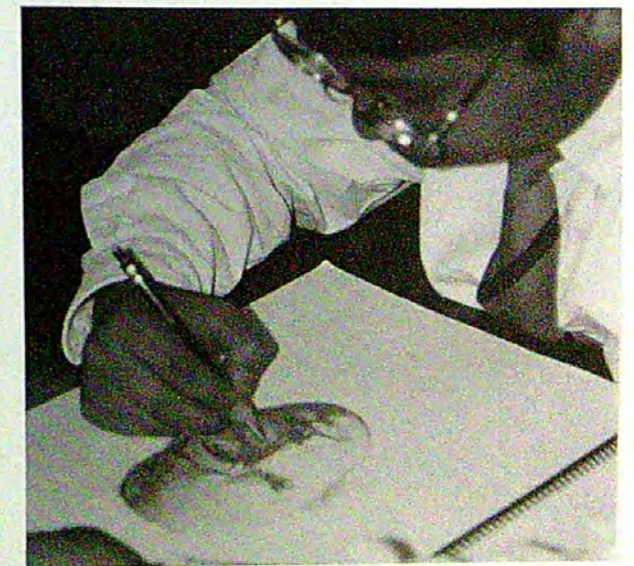
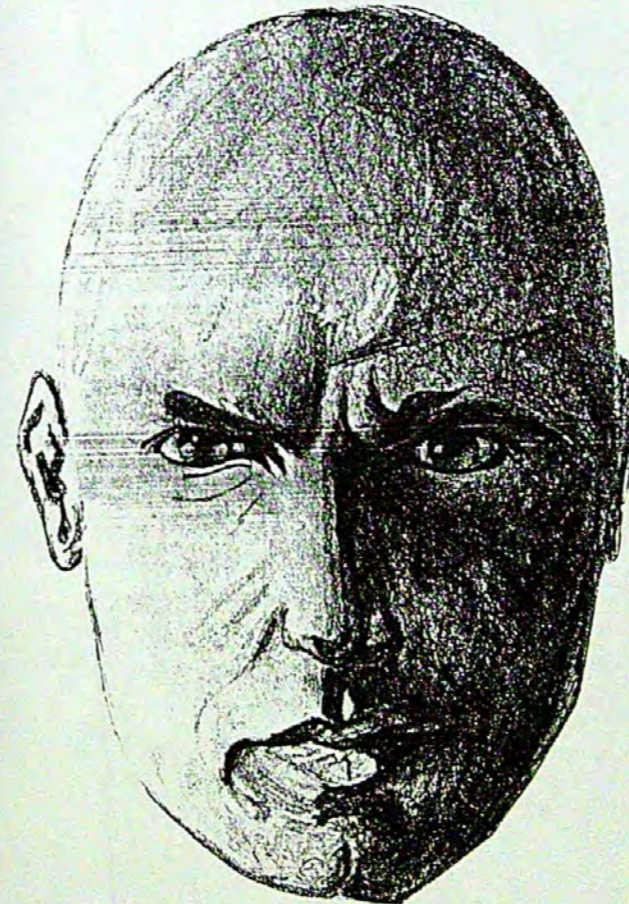
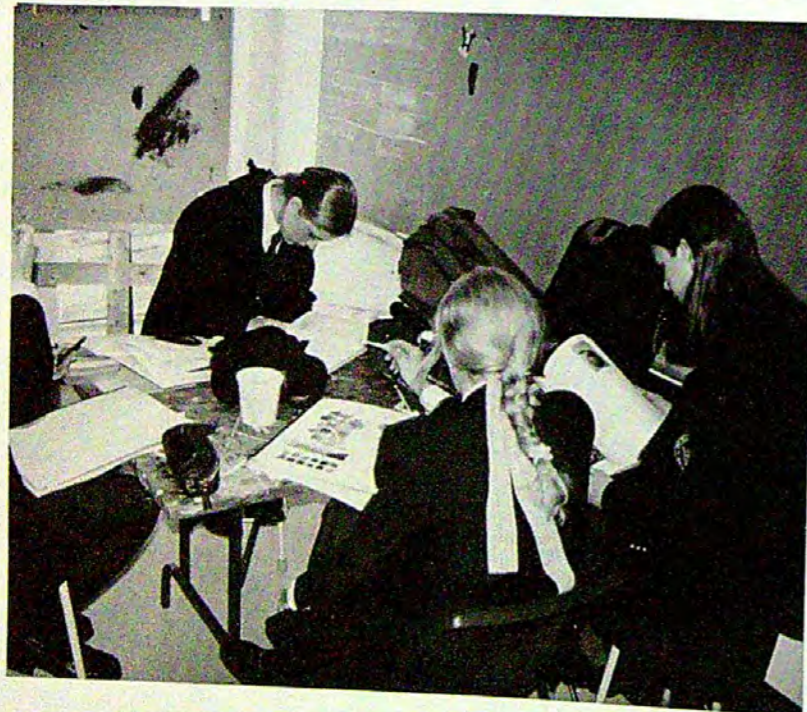

Literature!

This double page features artwork in the center of this page by Jay Banister, an interview with the English teachers below, excerpts from Grade Eleven short stories by Bill Koutselas and Pat Loftus, and an excerpt from a Grade Nine short story by Eric Grochowski. Also on the opposite page are poems by Chantelle Styles (Grade 10), Laura Grant (Grade 7) and Monica Fofie (Grade 10).

Interviews with the English Department

by Jothy Sanghera and Morgan McGregor

In order to introduce the samples of student writing seen in this section, we approached the West Island English teachers with a few general questions about their subject and teaching styles:

Yearbook: What direction do you like to take when teaching this subject?

Ms. Webb: I enjoy teaching kids to think for themselves, to communicate and to have fun. I expect students to use their creativity to become better in many different areas in English.

Yearbook: What format or style of writing do WIC students tend to be best at?

Ms. Morin: That depends on the individual student of course, but many of the West Island College students I teach tend to be strong at structured writing in general and essay writing in particular.

Yearbook: What is your favourite part of teaching English?

Mrs. McGee: I like teaching about issues that I am interested in and stories that I personally enjoy, and those I believe students will like - I like to see their enthusiasm. I also enjoy stirring up controversy, and that has led to serious formal debates at the Grade 7 level which I hope to expand to other levels.

Yearbook: How is English important to students in their future?

Ms. Morin: Students develop many skills in English class that are important to their future. English helps one think - it requires thought and creativity. Good command of English is an essential ability in everyday life and is useful in all careers and lifestyles.

Yearbook: Do you have a favourite Grade or age that you teach?

Mrs. McGee: Not really - I teach students in Grade 7, Grade 10 and Grade 12, and I enjoy the mix of ages and interests. Good writing is good at any grade.

Yearbook: What type of work is best for students to develop their skills in English?

Ms. Webb: Many different types of practice are necessary, but I particularly like projects that help students develop independent work skills and habits, and that lead students to build confidence and to believe in themselves.

The Test (an Excerpt)

by Eric Grochowski

... It's been about a day since I woke up from the machine. Memories are flowing back constantly. The hardest one to believe is that I willingly put myself in the machine. I just don't remember why. The building I'm in is completely deserted except for me. The outside walls are five meters thick, and outside them is just endless desert. There is enough unperishable food in the building to last me three months, and a fresh water well is in the basement. I didn't know what was going to happen next until I found a letter I wrote 30 years ago (before I entered the machine), to myself...

Dear James,

I understand your difficulty in comprehending what's going on, so please excuse me for being frank. The world went into Thermo Nuclear War, at great risk of destroying or defacing Earth. So the U.N. decided that the only one way to make certain the human race and other life continued to exist was to put to sleep five human beings and a large group of animals in separate heavily armoured compounds, and have machines wake them up after all was cleared. In case you've wondered, your at the bottom of what used to be the Arctic Ocean. The four other humans will come to you five days after you 'wake' from the machine. Here is the code to wake the animal compound, which also contains living quarters for you and the others: 0012-333-456/12.humfab/89.

*See you in the mirror,
James Amatello
President of the United States of America*

Eye to Eye (an Excerpt)

by Bill Koutselas

... About a million thoughts raced through my head. My childhood memories of growing up. What would happen to my dogs if I died? Was there life after death? I couldn't think anymore. I had to react quickly, yet careful as to not miss. The next sound was the tranquilizing rifle going off. It was like an enormous wave that rushed in towards us, crashing in on all sides. My gun was thrust over the cliff by the powerful paws of the puma. I hadn't even grazed her. She timed it all so perfect. She had won, and I had lost.

Filled with excruciating pain, I found myself staring once again, into Margarita's eyes. She was on top of me. My heart was ecstatic. It felt like one hundred pounds was put on my chest. I was certain that I would die. It wasn't the way that I wanted to die but it wasn't as if I had a choice either. Then, just as quick as she had pinned me to the ground, she leaped into the air and was out of sight in less than three seconds. I couldn't believe it. It was like she was giving me a second chance. Telling me to think about what I was about to do. Showing me that out of her own free will, she let me live. It was then that I truly saw eye to eye with Margarita.

From a Distance

by Chantelle Styles

From a distance

You shine so bright

You're so far yet
you feel
so close

Your glow gives me energy.

As I sit alone on this hillside,
I watch you in amazement.

How can something so distant
feel so
connected to me

I could sit here for hours just

watching,
staring,
watching

I become mesmerized by your beauty

Your brightness sends c
h
i
lls through my soul.

Angels

by Laura Grant

Angels
Singing

Sometimes

Sometimes I wonder
about a lot of things
about why the grass is green
about why the sky is blue
sometimes I wonder about so many things

why I am here
why I am not
sometimes I wonder

If some people should be here
or if they are better than I
or if I am better than them

sometimes I wonder
where I would be
if I wasn't here
right now

sometimes I wonder
If this is the right place
but in my heart I know it is
so therefore I think I should
keep on wondering

but I should keep it to myself

Showdown in the Sun

by Pat Loftus

... Rico, a perfectionist, despised incompetence. He couldn't understand why people could not carry out orders properly. He had a very short temper, people described him as a bomb waiting to go off, an accident waiting to happen. He either loved you or hated you. A person always wanted to be loved by Rico because if he hated you other people did too. Don't get me wrong, there was a lot of people who did not like Rico Sanchez. The American D.E.A. (Drug Enforcement Agency) and the C.I.A. both considered destroying Mr. Sanchez's drug empire one of their top priorities. Rico knew this and ran his operation with caution...

When I Was . . .

by Monica Fofie

When I was 6, I was young
I chased rainbows and butterflies
and I never stopped to
look behind
When I was 15, I grew old
the magic had stopped the
visions were dim,
I couldn't remember butterflies
When I was 45, I was ancient,
I chased shadows
my vision was black and dark,
I could no longer see the colours of the rainbow,
but when I was 85,
I grew young.
My hair turned grey, my skin
loosened and I learned
to chase rainbows
and not look behind.

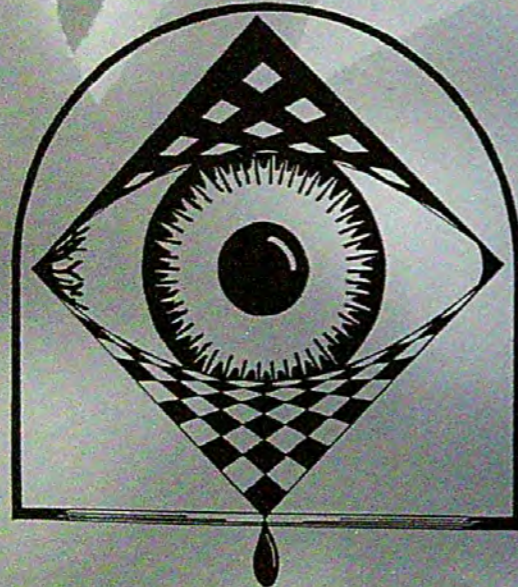

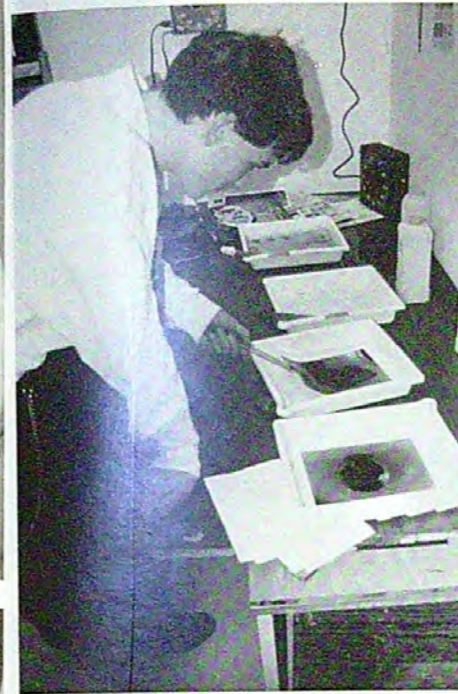
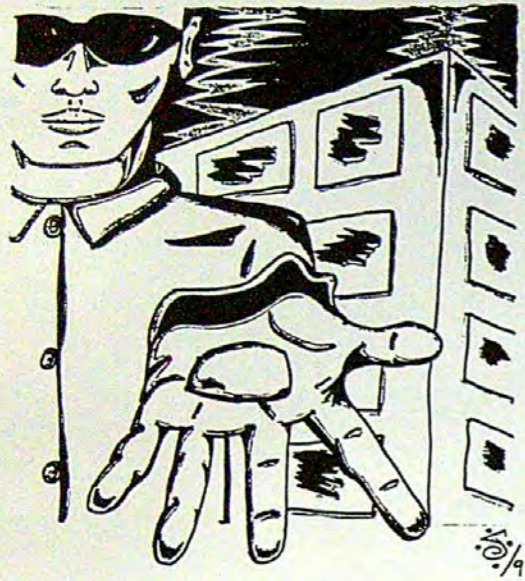

These two pages show a number of different grades and a variety of projects in the Art Room. Above and below are two samples of the work of Simon Goodspeed, and Simon is pictured in two photos at the top of these pages at work in the Dark Room developing photographs for the school newspaper. Opposite in the top right hand corner is artwork by Krista Nichol. Also opposite is a photo of the Grade Nine display wall featuring watercolor work, and a number of candid show Grades Seven, Nine and Eleven at work.

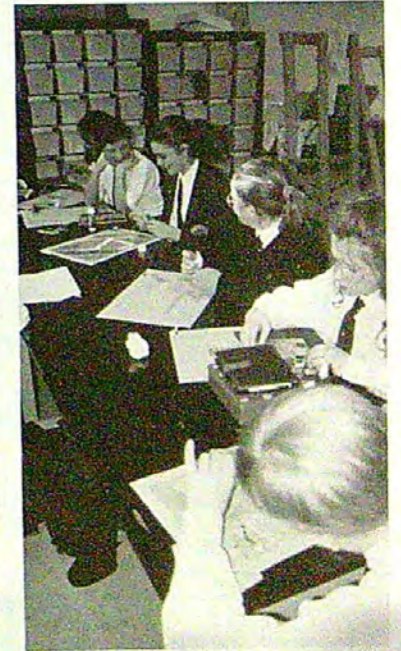

Words from W.I.C.

Ms. Morin's class completed an exercise in writing poems modelled after published poems. The students followed the format set by the published poet to create their own poems. A few examples appear on this page. The published poem *Noise* by J. Pope is modelled by Grade Nine students Stephanie Winters and Jill Ewens in their poems, entitled respectively, *Driving* and *My House*. As well, Robert Burns well-known *O My Luv's Like a Red, Red Rose* is modelled by Grade Nine student Eric Grochowski in his poem, *O My Bed's Like a Soft, Fluffy Cloud*.

Noise
by J. Pope

I like noise.
The whoop of a boy, the thud of a hoof,
The rattle of rain on a galvanized roof,
The hubbub of traffic, the roar of a train.
The throb of machinery numbing the brain.
The swithing of wires in an overhead tram,
The rush of the wind, a door on the slam,
The boom of the thunder, the crash of the waves.
The din of the river that races and raves,
The crack of a rifle, the clank of a pail,
The strident tattoo of a swift-slapping sail -
From any old sound that the silence destroys
Arises a gamut of soul-stirring joys.
I like noise.

My Luv's Like a Red, Red Rose
by Robert Burns

O my Luv's like a red, red rose
That's newly sprung in June;
O my Luv's like the melody
That's sweetly play'd in tune.
As fair art thou, my Bonnie lass,
So deep in Luv am I;
And I will luve thee still, my dear,
Till a' the seas gang dry,
Till a' the seas gang dry, my dear,
And the rocks melt wi' the sun;
I will luve thee still, my dear,
While the sands of life shall run,
And fare thee well, my only Luv,
And fare thee well a while!
And I will come again, my Luv,
Tho' it were ten thousand mile.

Driving (modelled after the poem 'Noise'
by J. Pope)
by Stephanie Winters

I like driving.
The honk of the horn, the slam of a door,
The sound of our feet upon the floor,
The ringing of trains that come so rare,
The whoosh of the wind as it blows through
my hair,
The click of the key inside the ignition,
The tick of the signal in timed repetition,
The roar of the motor as you rush down the
street,
The boom of the music with it's loud,
steady beat,
The splash of the water as we go through a
puddle.
The crash of the car when I know I'm in
trouble,
With the silence the sound of the car de-
stroys,
Comes an array of overwhelming joys.
I like driving.

My Bed's Like a Soft, Fluffy Cloud (modelled after 'My Luv's Like A Red, Red
Rose' by Robert Burns)
by Eric Grochowski

O my Bed's like a soft, fluffy cloud
That's newly sprung in a dream,
O my Bed's like the journey
That's calmly made by steam.
As soft art thou, my cumffy Bed,
So deep asleep am I;
And I will rest on you still, my Bed,
Till my exhaustion shall die,
Till my exhaustion shall die, my Bed,
And my dreams melt with the sun;
I will rest on you still, my Bed,
While your comfort is not on the run,
And keep your comfort, my only Bed!
And keep your comfort awhile!
And I will be tired again, my Bed,
For work can be so vile.

My House (modelled after the poem 'Noise'
by J. Pope)
by Jill Ewens

I like my house.
The ring of the phone, the buzz of the
showers,
The blare of the radio, the crash of the
towers,
The call of my mom, the bark of the dog,
The song of the doorbell, the swish of the
fog,
The talk of my brother, the bounce of a ball,
The head of a doll thrown against a wall,
The squeak of the door, the scratch of a pen,
The jump of my sister, the laugh of the men,
The click of a keyboard, the slap of the
door,
The bump of the groceries being plopped on
the floor
From any old thing that my house keeps in
I thank it, for it helps me always to win.
I like my house.

Words from
W.I.C.

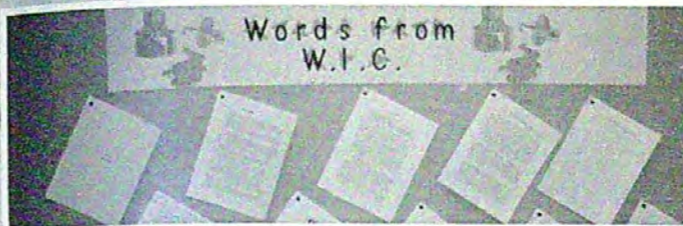

The Sapling
By Craig Goldie

Burst through the mossy ground,
A sapling stands without a sound,
A sliver in a forest of ancients
Who are overhead with infinite patience.
Suddenly a noise breaks the silent beat,
The noise of tiny, pattering feet.
The child, like the sapling, is dwarfed here,
but doesn't express any signs of fear.
The boy spots the young tree and starts into a run,
then stands over the sapling like a father over his son.
He reaches down with his massive paw,
It seems like he's about to play God.
He reaches for the bottom of the tree
And with a supreme effort, starts to pull.
The sapling groans in protest and says:
"I'm too young, why must it end like this?"
The boy keeps pulling, stubborn as a bull.
Eventually, as the whole forest stops to watch
This bitter end to life, the baby is
Broken free from it's shallow bed
And falls limp in the boy's hand.
Tired with this game, the boy goes off
To find another.

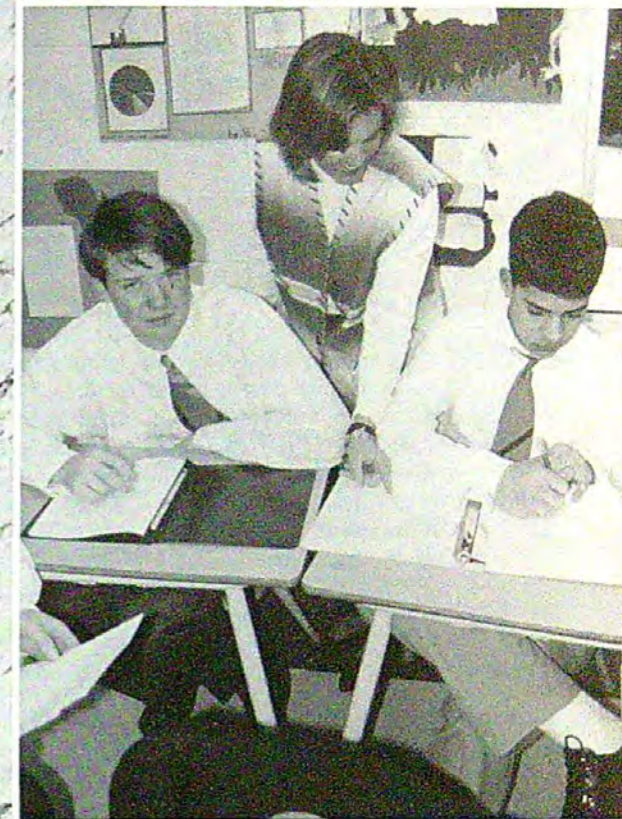

A Candle's Flame
By Kamil Umar

The tiny flame burns like a sliver of the sun.
It grabs the wick for life,
As the wind makes it shiver in the night.
The sputter of the flame,
Causes the shadows to go insane.
Twisting, turning, twirling it moves dancing a ballet.

All with in a single flame.

Then suddenly a hurricane of wind strikes,
And it sputters out of life,
As fickle as a roll of the dice,
As is usually the way with life.



This page obviously features samples of student writing from WIC students along with photos of their English teachers. Below: Ms. Morin is pictured with her student winners of a writing contest: (from left to right): Craig Goldie, Eric Gruchowski, Daniel Gillean - with the thoughtful pose, Kamil Umar, Jordan Kim and Steve Jackubec.



Grade Eight Pointalism Projects

Pointalism is artwork started in sketch form and filled in with ink dots in different areas of the picture. The shade of each area is determined by the number of dots, ranging from none for white areas, to a few for light grey, to many for darker greys to areas that appear black due to dots being so close to one another.

On this page, the Grade Eight students who completed this artwork were: (LEFT TO RIGHT) TOP ROW, AT RIGHT: Jill Marcotte
SECOND ROW: Julia Bouvry, Desiree Fofie, and Nathan Hayashi
THIRD ROW: Jeff Johnson, Alicia Hunter, Ali Kellough, and David Chalmers
FOURTH ROW: John McGee, Sandy Wong, Kent Swanlund, and Amish Patel



Artwork on this page is by: (LEFT TO RIGHT) TOP ROW: Mikyla Conway, Laura Tinline, Lara Patterson, Adam Spragins. SECOND ROW: Morgan McGregor, Mac Homme, Jessica Park. THIRD ROW: Erin Lester, Stephanie Keefe, Fady Girgis. FOURTH ROW: Lorraine Lau, Vanessa Jacobs.

BOTTOM ROW: David Loftus, Jen Waslen, and Nicci Soutiere.

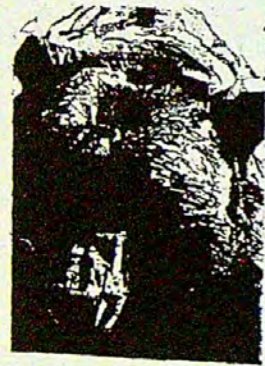

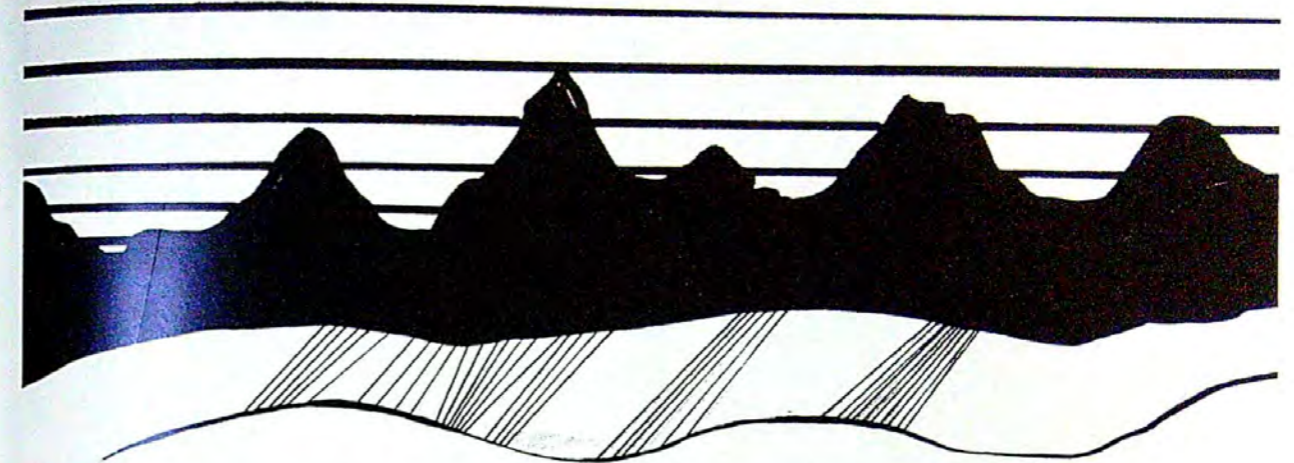

Artwork on this double page includes artwork by: TOP LEFT: Adriana Hunstad, Grade 10 TOP RIGHT: Nick Zikopoulos, Grade 10 LEFT: Monica Fofie, Grade 10 ABOVE: Monica Fofie, Grade 10 BELOW: Liv Watson, OPPOSITE PAGE: Liv Watson, Grade 10

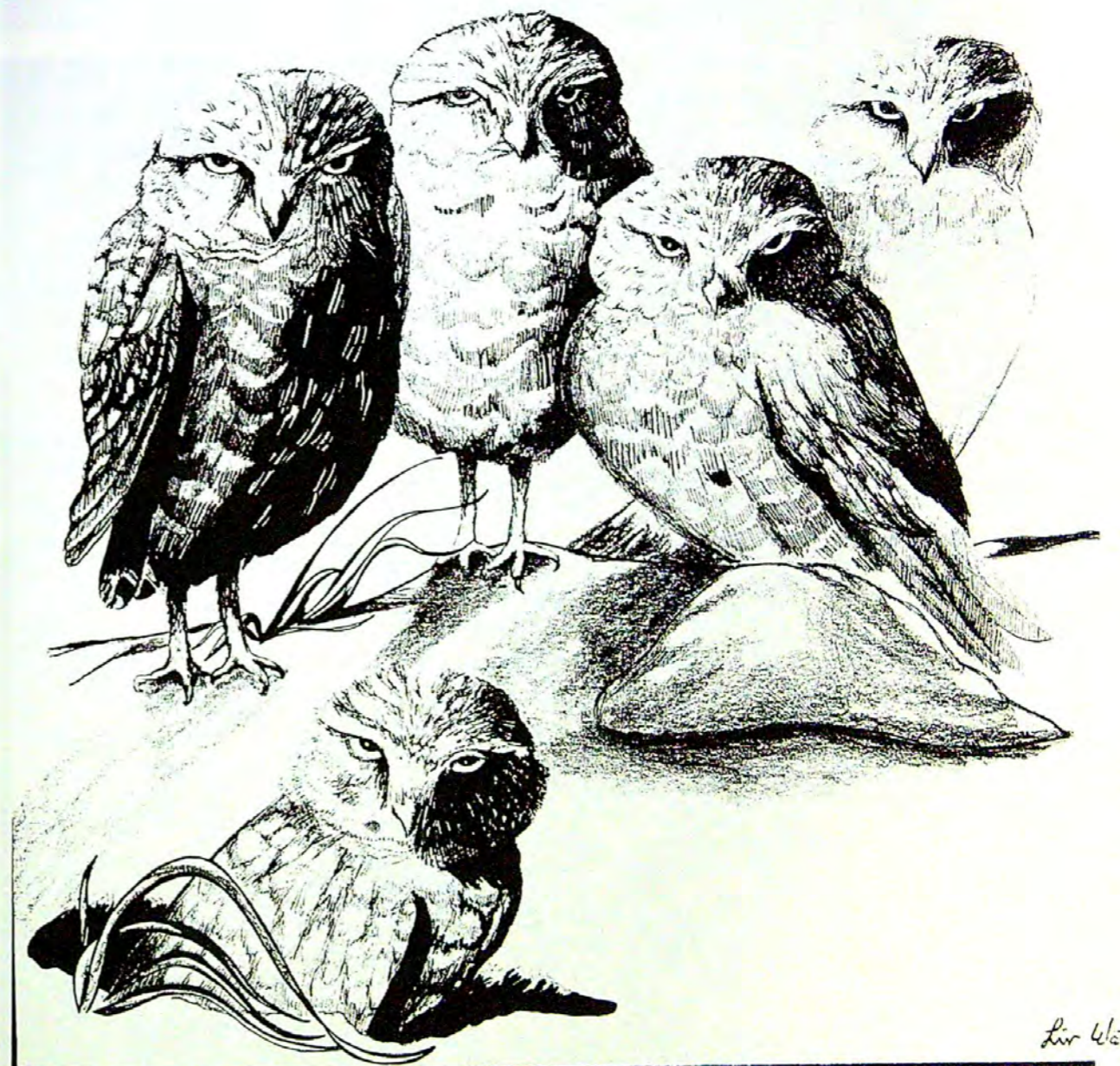

Liv Watson

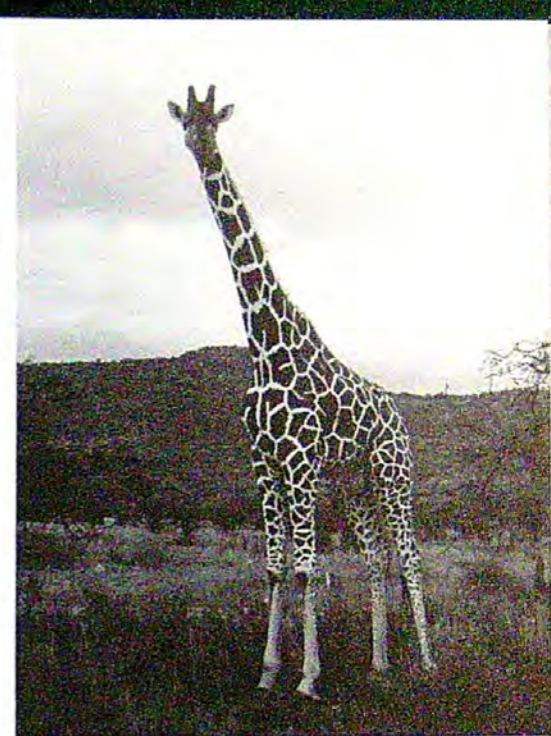
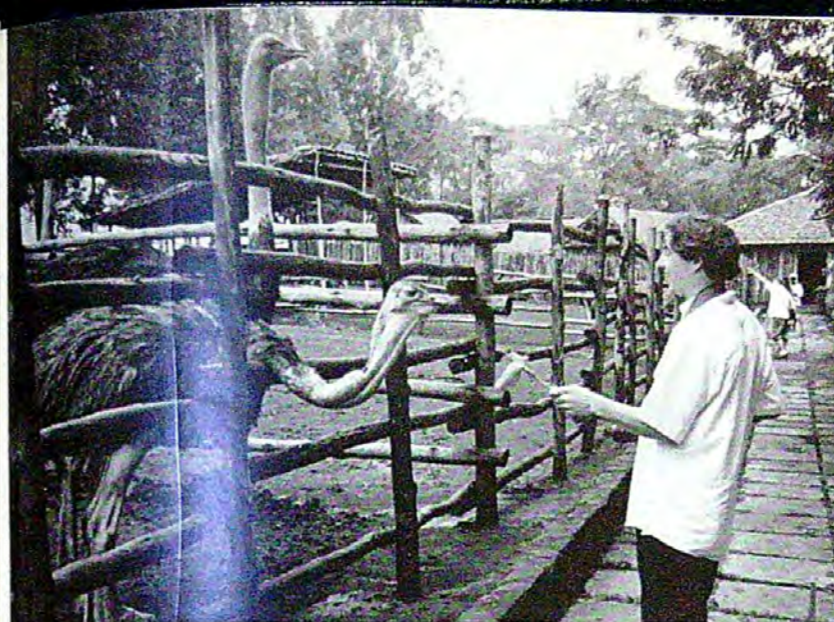

1995 Travel Study Program: Kenya

Over the Easter vacation, Mr. Forrester led a group of W.I.C. Calgary students pictured above, on the school's annual spring travel - study program - this year destined to safari for 8 days in Kenya. The group met up with a similar group from the West Island school in Montreal and then flew to Nairobi and toured the Kenyan capital, then ventured to Samburu National Park, then Lake Nakuru where 13 rhino were seen (an unusually high number for such a rare and endangered species), then to Mountain Lodge at the foot of Mount Kenya, where the morning view of elephants shown at the bottom of this page was spectacular, and then finally on to Masai Mara National Park, which is perhaps the most famous safari park in the world - and it did not disappoint as the pictures of feeding cheetahs, giraffes and other animals indicate. Highlights of the trip included the unforgettable sight of warthogs mating, the visit to the Carnivore Restaurant (where Anita could not bring herself to eat the many types of animals she had just seen on safari), and an unexpected visit to the village of Isiolo when the tour bus broke down and where children from the village met with our students and exchanged lessons in each other's language and left a lasting human memory of a terrific trip.

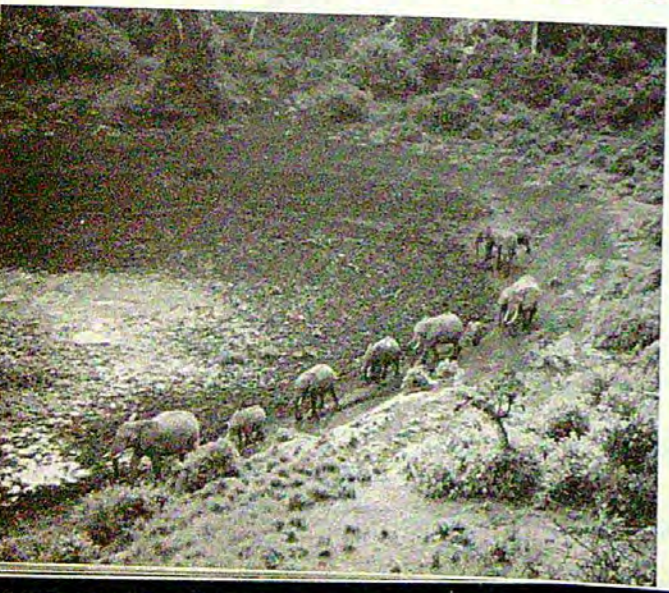
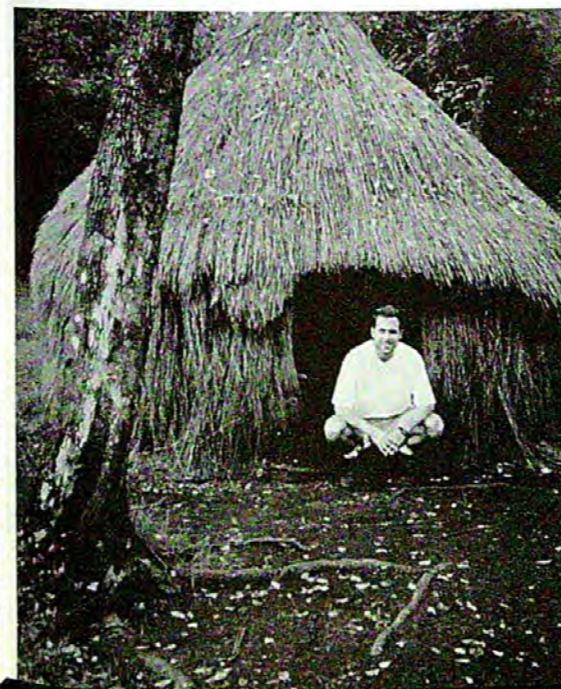
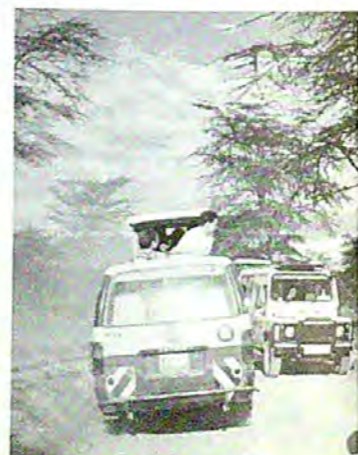

Candid Potpourri

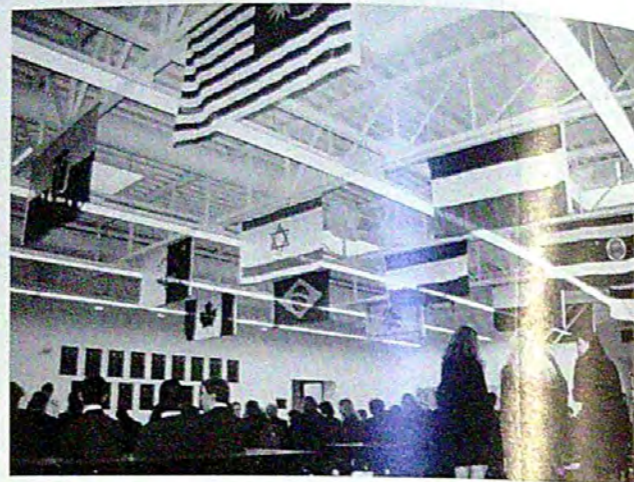

Hallway Candid



Captions

TOP LEFT: Great hall with no flags on the ceiling TOP RIGHT: The ceiling became more colorful throughout the year MIDDLE RIGHT: "What we really learn in school!" RIGHT: "Just practicing our moves for the W.I.C. dance." BELOW: "No autographs, please!" ABOVE: "What we all feel like after a tough class!" MIDDLE ABOVE: "Kiss me, you fool!"



Staff Candid



Captions

TOP LEFT: Surrounding the Competition: person in the middle of Mr. Grant and Mr. Forrester is the Headmaster of Strathcona TOP RIGHT: "Dunk the Hunk" ABOVE LEFT: "I love these intercom/phones, they make me so powerful!" ABOVE: Teacher Alumni ABOVE RIGHT: The laughs keep right on coming at WIC LEFT: "Don't even think about talking" RIGHT: "Why won't these Seniors just leave me alone?"



New Students Candid

The students pictured here joined later on in the school year, and could not be included on their regular Grade page. But they were more than welcome additions to West Island College 1995!
(LEFT TO RIGHT): Mark Bauman (joined the Grade 12 class for Semester #2, and will be graduating in January of next year); Thomas Ferianec (joined the Grade 10 class for later part of the second semester); Michael Anderson (joined the Grade 11 class part way through the first semester); and David Uniacke (joined the Grade 11 class for the second half of the year).

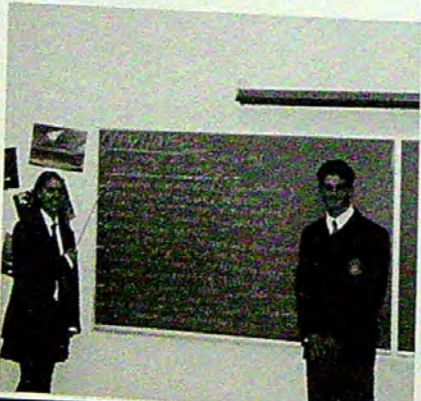
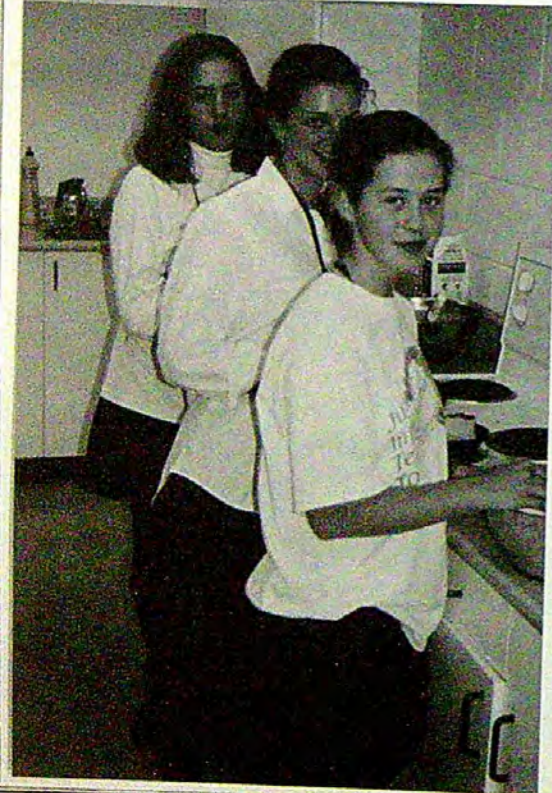
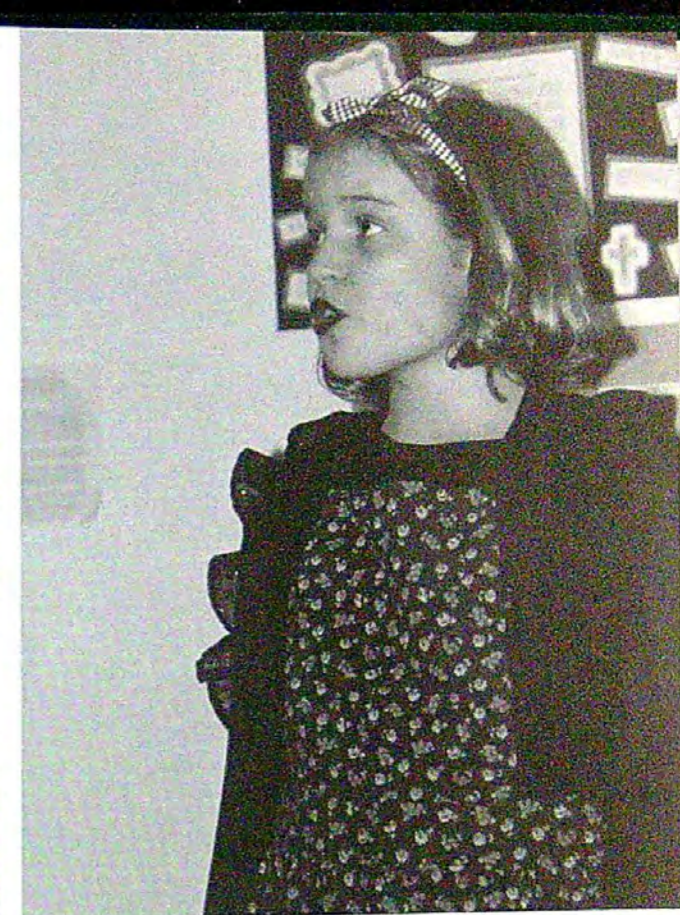
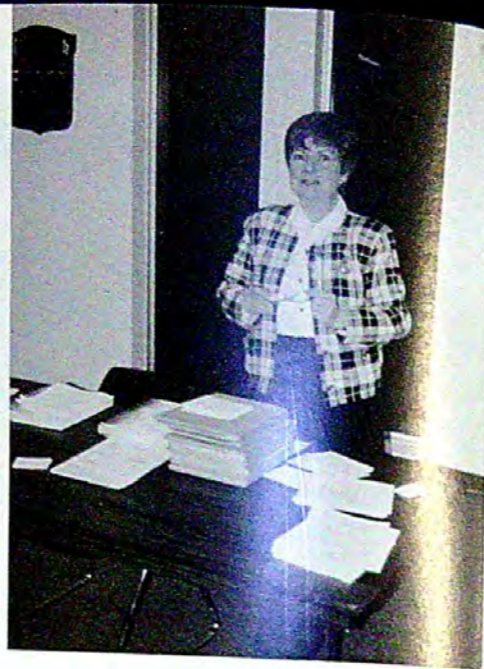
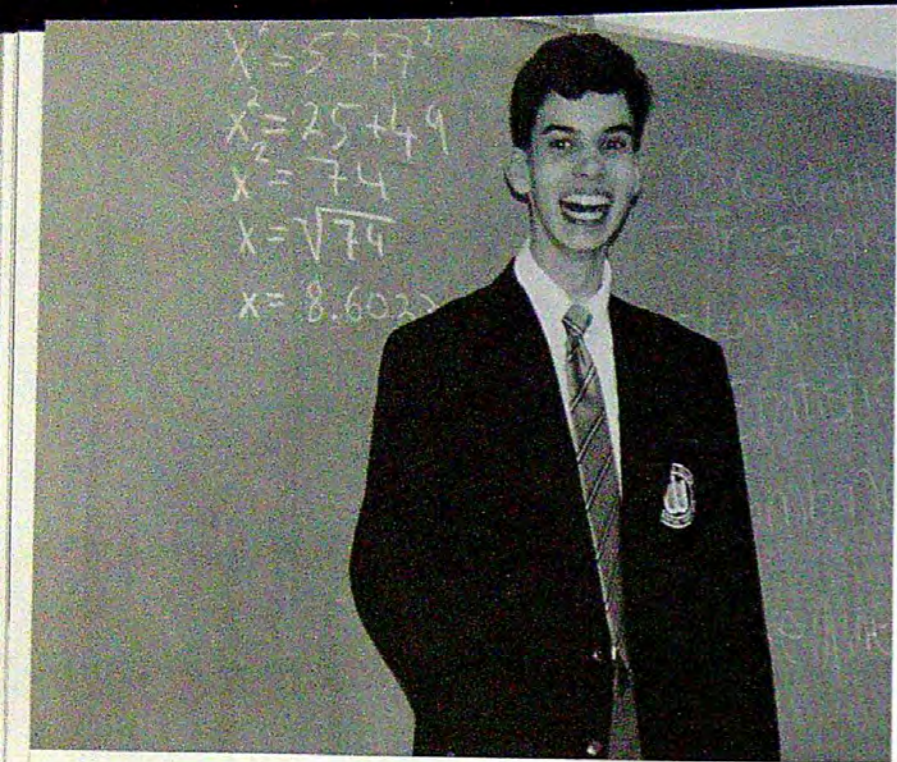

Open House

On the evening of December 1st, 1994, West Island College welcomed visitors, parents and the Calgary community at large into our school. Presentations were given by students in classrooms, scenes from English plays were performed, student-produced videos were shown, sports were demonstrated in the gymnasium, computer programs written by the students were run, and example lessons were given. Those in attendance were given a glimpse at a day in the life of West Island College.

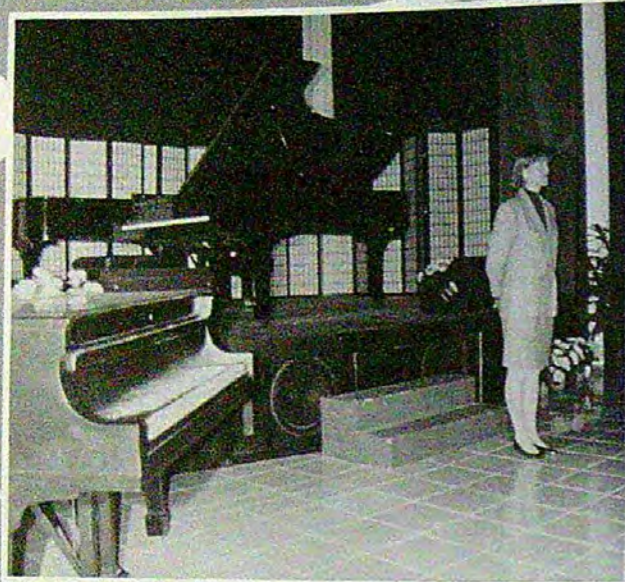

The son of two engineers, Dimitrij Teterin was born in Moscow, Russia in 1971. He studied piano from the age of six, first at the Central Music School and subsequently at the Moscow P.I. Tchaikovsky State Conservatory under Malinin and Orpova.

Teterin has performed in solo recitals, chamber recitals and with orchestras in Russia, Poland, Bulgaria, Canada and the USA. He was the guest artist for Mikhail Gorbachev during his Canadian tour. He has delighted audiences in Calgary's acoustically perfect Jack Singer Hall. His performances with the Okanagan Symphony in 1993, and solo in Amherst (Ohio), Atlanta, Gauseville and Rome (Georgia) earlier this year, brought rave reviews from audiences and promoters.

The growing list of Teterin's accomplishments includes the Silver Medal at the prestigious Ota Bachauer International Piano Competition in Salt Lake City, Utah in June of 1994. In 1990, he received a diploma at the Chopin competition in Warsaw, Poland. In 1992, he won the "Special Promoter Award" at the Esther Hooten International Piano Competition in Calgary. This award is granted to a "young artist" who demonstrates unique talent, sensitivity and curiosity with the promise of future brilliance. Recently, he won a Concerto Competition in Cleveland.

In May, 1991, Mr. Teterin was granted a scholarship to study at the Banff Centre for the Arts, under Gyorgy Sebok. Currently, he pursues scholarship studies in Cleveland. Among other engagements in 1995, he will perform a tri-city recital tour for the Okanagan Symphony, with Cicchetti in Cleveland, Vancouver and Athens, Greece.



Dimitrij Teterin

Piano Recital
December 5, 1994
Steinway Hall, Calgary

Programme

Domenico SCARLATTI
(1685 - 1757) Sonata in E Major, K139 (11 minutes)

Serge RACHMANINOV
(1873-1943) Etude Tableaux No. 6, A Minor, Op. 39 (The Wolf & Little Red Riding Hood) (2:11 minutes)

Franz LISZT
(1811-1886) Venezia e Napoli, Gondoliers, Canzonetta (11 minutes)

Serge PROKOFIEV
(1891-1953) Sonata No. 6 in A Major, Op. 41 Allegro Moderato Andantino Tercetto Et. Valzer Lento Adagio (16 minutes)

OFFER

This afternoon's performance has been made possible through the generous support of:
KACEE Exploration Inc. - Brian Skinner, President
and
CS Resources Ltd. - Dennis Sklar, President



CANDIDS

Grade Seven Mask Creation!

Ms. Flottat and her Grade Seven class spent some of their French classes preparing face masks moulded to the students' own faces for a French Project. They used blow driers to help the masks harden and then used them to present a French play!



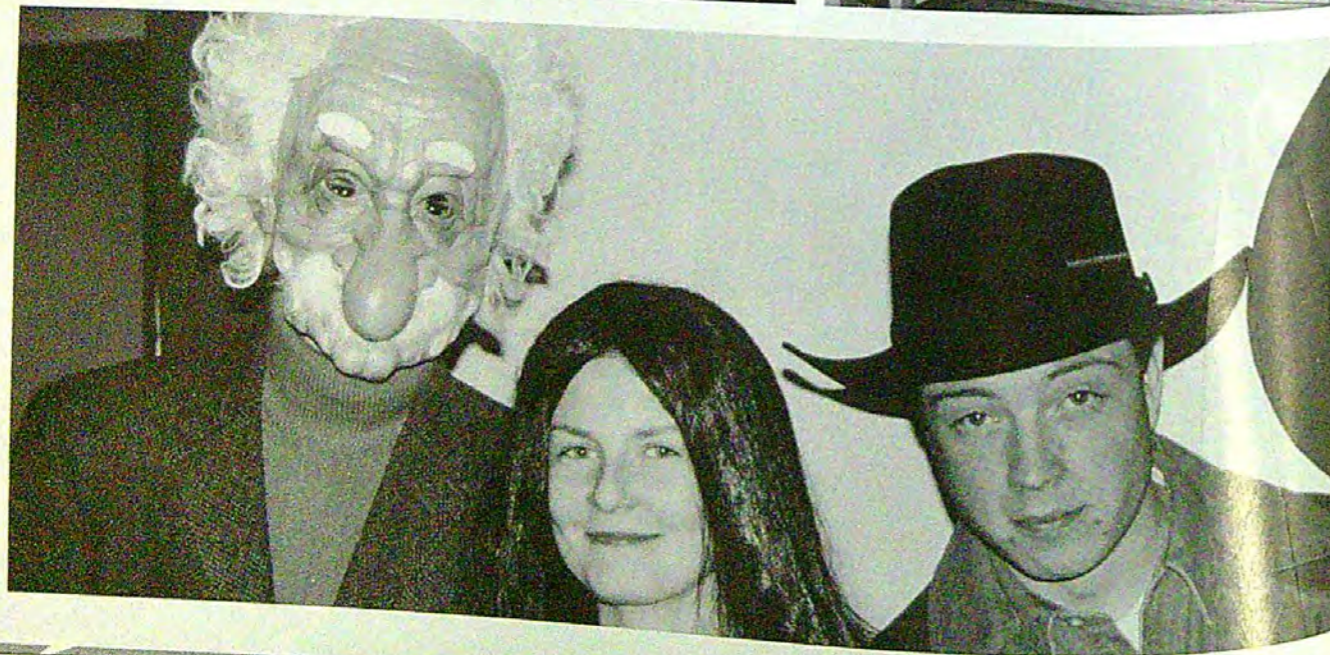
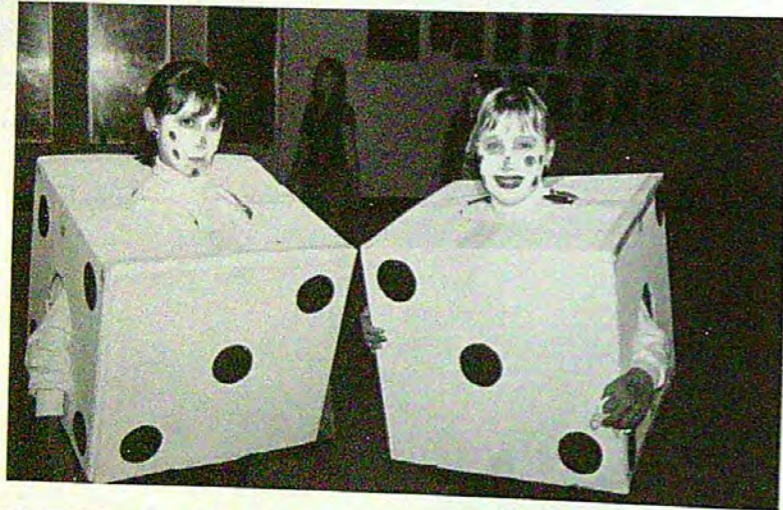
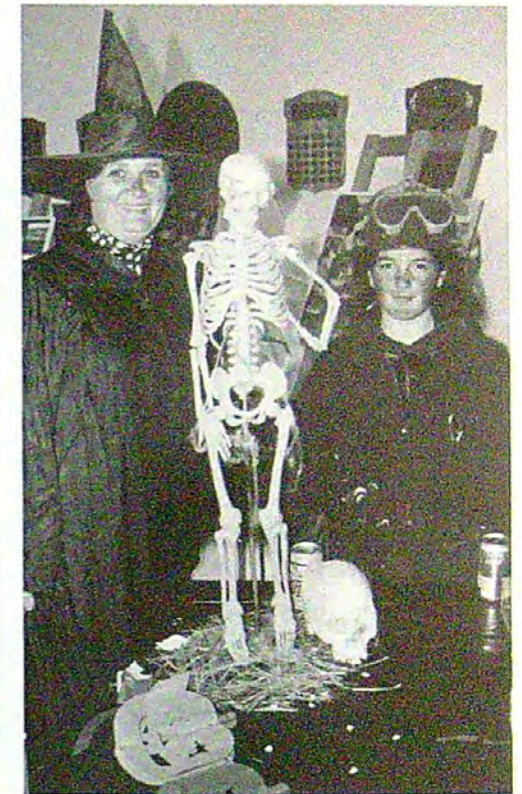

Hallowe'en Dance and Family Evening

The Hallowe'en Dance was also a family evening where parents, teachers and students got together at West Island College to play games and socialize. This was a good opportunity for West Island College parents to meet other families in the school. As the pictures on these two pages show, considerable effort was put into the evening - thanks to all involved in decorating, planning, preparing food and maintaining the pumpkin display - particularly Laura Huber, Donna Jakubec, Melissa Wigham, Jean Marcotte, Dale Lobsinger, Jane Owens and Lorraine LeBoldus.

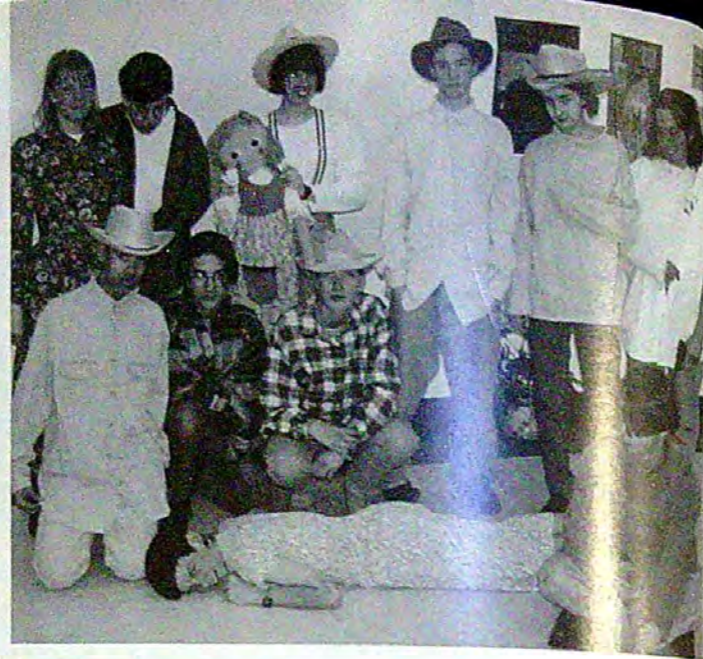

Drama Presentations and Dances

Over the course of this year there have been many drama presentations and dances. We had some great dances, like the one where we hosted Strathcona-Tweedsmuir. Ms. Webb-Brisco put on some evening drama performances, one with the Drama Club and others with the Grade Ten Drama class. We also included some pictures from the Speech Arts Competitions, where students used dramatic skills to address the student body. The Junior winners pictured with Mr. Forrester are for French Speech Arts and were Cal Patterson, Elizabeth Klaibur and Amish Patel. The Senior winners, unavailable for photos, were Dave Uniacke, Jessica Schovaneck, Rachel Wong, and Kristine Gagnon. The Junior English Speech Arts winners were Lindsey Jager, Elizabeth Klaibur, and Chris Murdoch.





Undergraduate Awards Evening

June 26th, 1995



The final evening at West Island College for the 1994-95 school year took place on June 26th, 1995, to celebrate the academic, extra-curricular and other achievements of the students through the past school year.

The evening began with Amy Skinner singing the national anthem, followed by welcoming remarks by Darren Forrester. Shaun Ford and Abena Boadi, this year's Head Boy and Head Girl, then read out the Headmaster's List for the overall year. Shaun and Abena are pictured reading out that list on this page, and the group photograph on this page is of the Headmaster's List members that were in attendance at this evening. A complete list of the final 1995 Headmaster's List is included next to this photo.

Academic awards by subject were then presented for all grades. Clubs and extra-curricular activities had one member each noticed for their special contributions, and the President's Honor Roll was then announced by Jack Grant. All these academic and extra-curricular award winners and their photographs are on the next double page.

The evening was not solely concentrated on academic success; Merit Award winners were called up to the podium so that effort, attitude and improvement could be recognized as well. Those winners are listed opposite next to their photo.

The concluding awards for the evening recognized many different contributions in major areas of school activity and performance. Those award winners are listed opposite and their photos appear on this double page. The Prefects for the 1995-96 school year were the last student group to be recognized, as the outgoing Prefects of 1994-95 handed out the Prefect ties to the new group, and both groups are pictured on this double page. Also outgoing Board of Governors' members Mr. den Boef, Mr. Goodspeed, Mr. MacLeod, Mr. Skinner, Mrs. Vosler, and Chairman Frank Bercha were honoured for their contributions to the school and photos of the latter three also appear here.

The evening was overall well-attended and a great opportunity to witness the students who tried and those who tried and succeeded. Congratulations to all!

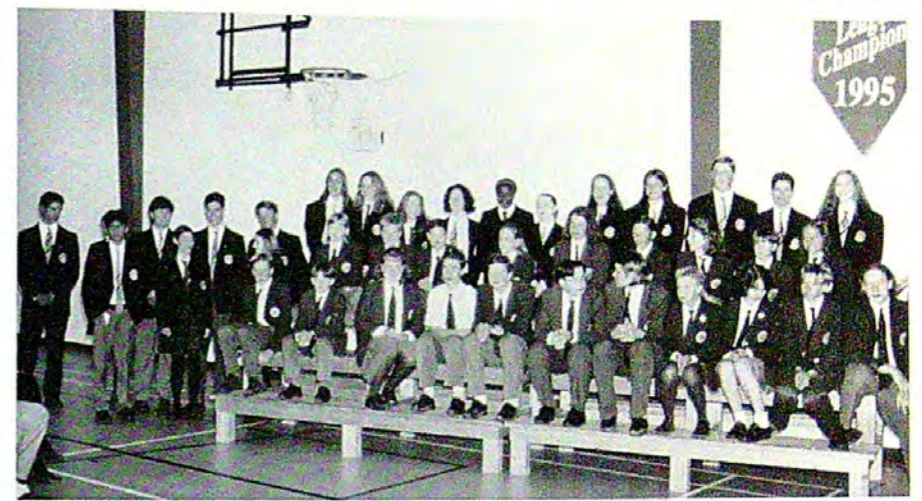

Merit Award Winners

Note: Not all Award Winners were able to be in attendance at the ceremony; therefore all winners are listed below, but in order of subject, not corresponding to the rows in the photo.

- Merit Awards - 1995
- Grade 7: 1. Andrea Elmore: Math, French; 2. Andrew Keeping: Math, Science; 3. Alana Gillman: FLA; 4. Christopher Murdoch: Social; 5. Jonathan Kelly: Social; 6. Jenny Steer: Science; 7. Elizabeth Klajker: English; 8. Adriana Jamniczky: English, Computer Studies; 9. Jonathan Owens: Physical Education; 10. Andrea Habermayer: Computer Studies; 11. Nicole Cordeau: Physical Education
- Grade 8: 1. Morgan McGregor: Math, Science, English; 2. Adam Spragins: Math, MST; 3. Jill Marotte: Math, Social, Science, English, P.E.; 4. David Loftus: French; 5. Kent Swanlund: FLA, Computer Studies (2nd semester); 6. David Chalmers: French; 7. Laura Tinline: Social; 8. Jessica Park: Social, Science, English; 9. Ryan Vosler: Computer Studies (1st semester); 10. John Olson: Physical Education; 11. Amish Patel: MST
- Grade 9: 1. Daniel Stoffman: Math, Science, English, Art; 2. Shane Hare: Math; 3. Steven Schuster: French, English; 4. Jared Leboldus: FLA; 5. Kamil Umar: Social; 6. Christy Skinner: Social; 7. Stephanie Winters: Science; 8. Lorie Markowsky: Computer Studies; 9. Craig Goldie: Computer Studies; 10. Callum Patterson: Physical Education; 11. Laurel Alexander: Physical Education; 12. Eric Grochowski: Art
- Grade 10: 1. Winnie Wan: French; 2. José Pilon: FLA; 3. Matthew Youens: Science, English; 4. William Bercha: Science, Biology; 5. Nick Livaditis: Math; 6. Claudia Haas: Math; 7. Ganick McIntosh: Physical Ed.; 8. Heather Jamniczky: Physical Ed.; 9. Bradley Klajber: Bio 20; 10. Kira Horsfall: Social, English; 11. Monica Fofie: Social; 12. Jennifer Bouree: Drama
- Grade 11: 1. Kelly Murphy: Math, Physics, Social, English; 2. Sarah Alexander: Math; 3. Maya Malik: Chem; 4. Patrick Lefores: Social; 5. Kevin Howson: Physical Ed.; 6. Michael Sugimoto: Communications; 7. Bernadette Wong: French; 8. Rachael Wong: FLA; 9. Kristine Gagnon: English; 10. Faisal Dosani: Biology, Chemistry; 11. Adriana Sztuczka: Biology; 12. Kian Rasa: Physics
- Concluding Awards: Alim Mawji (President of the Student's Council); Amy Skinner (President of WICAA); Ryan Lailey and Morgan McGregor (Editors of Voyages - West Island Yearbook); Elizabeth Klajber and David Unacke (Excellence in Public Speaking); Matt Youens (Senior Computer Science Award); Andrew Keeping (Cody Chipman Award); Catherine Sharp (Perry Bedard Shield); Steven Schuster (Ken McCaffery Award); Aksel Neilson (Most Improved in French - 7E); Amy Skinner, Maya Malik, Kian Rasa, Heather Jamniczky and Kira Horsfall (Board of Governor's Award); Prefects for 1995-96: Kian Rasa (Head Boy), Maya Malik (Head Girl), Kevin Howson, Catherine Sharp, Jennifer Johnson, Michael Sugimoto, Michael Anderson, Kelly Murphy, Kristine Gagnon.

Headmaster's List Year End - 1994/1995 Junior School

- | | | | |
|---|---|--|---|
| Loucheud | McDougal | Perry Bedard | Terry Eise |
| Gillean, Alana
Lambert, Denis
Lau, Lorraine
McGregor, Morgan
Cibulskis, Valerie
Owens, Jonathan
Park, Jessica | Elmore, Andrea
Fofie, Debbie
Garrett, Gillan
Grass, Jennifer
Jamniczky, Adriana
Patterson, Callum
Daniel Stoffman | Elkad, Kam
Grant, Laurie
Lubangger, Michael
Lofus, David
Meyzide, Jill
Merrivory, Lorne
Palm, Amosh
Patterson, Lora | Bouvy, Julie
Grochowski, Eric
Wesling, Andrew
Klajber, Elizabeth
Lester, Eric
Newson, Joseph
Olson, John
Spragins, Adam
Swanlund, Kent
Wassler, Jennifer |

Senior School

- | | | | |
|---|--|---|--|
| Loucheud | McDougal | Perry Bedard | Terry Eise |
| Barnes, Lianne
Bourke, Jennifer
Freeman, Jennifer
Hamel, Andrea
Hunstad, Adrianna
Micka, Mark
Sharp, Catherine
Stiles, Charlette | Bercha, William
den Boef, Teresa
Fofie, Anita
Fofie, Monica
Jamniczky, Heather
Linder, Kimberley
Pilon, Jodie
Rasa, Kam | Gagnon, Kristine
Horvath, Mira
Lobb, Siwa
Mayer, Andrew
Rid, Julianne
Skinner, Amy
Soudern, Stacy | Cherney, Michelle
Evant, Joan
Goff, Neil
Haas, Claudia
Howson, Kevin
Malik, Maya
Murphy, Kelly
Sztuczka, Adriana
Youens, Matthew |



Academic Award Winners by Grade and Subject

Grade Seven: Elizabeth Klaiber (French 7E); Adriana Janniczky (French Language Arts, Social Studies, Physical Education, and Science (tie)); Andrew Keeping (Mathematics, English, Computer Science, and Science (tie)).

Grade Eight: Desiree Fofie (Physical Education); Adam Spragins (Computer Science (tie)); Fady Girgis (French Language Arts); Jill Marcotte (French 8E); Morgan McGregor (French 8B, Social Studies (tie)); John Olson (Mathematics, English, Science, Social Studies (tie), Computer Science (tie)).

Grade Nine: Shane Hare (French Language Arts); Christy Skinner (Physical Education); Eric Grochowski (Computer Science (tie)); Daniel Stoffman (Computer Science (tie), French); Craig Goldie (Mathematics, English, Science, Social Studies).

Grade Ten: Rehana Allidina (French); Jennifer Bourée, Chantelle Styles, Michelle Ratpan, Matthew Youens (tie - Drama); William Bercha (Biology 20 (tie)); Monica Fofie (Biology 20 (tie)); Heather Janniczky (Biology 20 (tie), French Language Arts, Science, Mathematics, Social Studies, English, and Physical Education).

Grade Eleven: Rob Iverach (Physics 20); Maya Malik (Social Studies); Sonia Lota (French); Catherine Sharp (French Language Arts); Rachael Wong (English); Michael Sugimoto (Biology 30); Kevin Howson (Mathematics, Chemistry and Physical Education).



Outstanding Performance by Grade:

Grade Seven: Andrew Keeping (93.9%); Grade Eight: John Olson (92.1%); Grade Nine: Craig Goldie (86.2%); Grade Ten: Heather Janniczky (94.3%); Grade Eleven: Kevin Howson (89.8%).

Top Academic Students:

Junior: Andrew Keeping Senior: Heather Janniczky

Achievement in Extra-Curricular Activity

Debate Club: Andrew Keeping; Newspaper Club: Daniel Stoffman; Spanish Club: Mark Mjeda and Andrew Keeping; Gauss Math Competition: Elizabeth Klaiber, Jen Waslen, Jill Marcotte, Emily Mackie, Caitlin Moore, Andrew Keeping; Peer Support: Kim Linder; Service Club: Jessica Park.



President's Honour Roll Year End- 1994/1995 Junior School

Lougheed

Girgis, Fady
Lau, Lorraine
McGregor, Morgan

McDouqall

Fofie, Desirée
Janniczky, Adriana
Tinline, Laura

Perry Bedard

Goldie, Craig
Grant, Laura
Loftus, David
Marcotte, Jill
Patel, Amish

Terry Fox

Bouvy, Julia
Keeping, Andrew
Klaiber, Elizabeth
McKinnon, Laura
Olson, John

Senior School

Lougheed

Barnieh, Lianne
Choy, Leo
Hamel, Andrea
Hunstad, Adriana
Sharp, Cathenne

McDouqall

Bauman, Mark
Bercha, William
Fofie, Anita
Fofie, Monica
Iverach, Robert
Janniczky, Heather
Pilon, Josée
Rasa, Kian
Reti, Christina

Perry Bedard

Elliott, Caroline
Gagnon, Kristine
Horsfall, Kira
Loftus, Patrick
McLeod, Brendan
Skinner, Amy
Sugimoto, Michael
Wong, Rachel

Terry Fox

Gohill, Neil
Haas, Claudia
Howson, Kevin
Klaiber, Bradley
Malik, Maya
Murphy, Kelly
Youens, Matthew

Alumni Night Candid

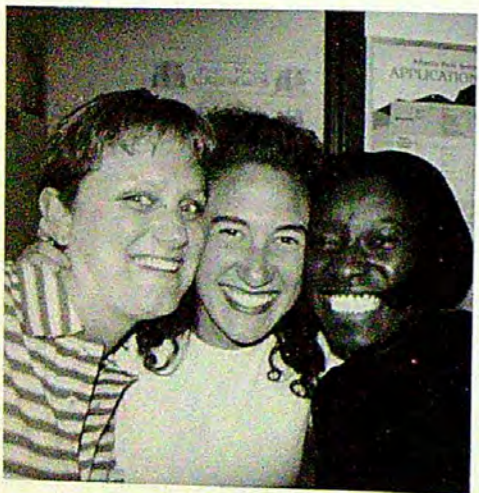

La Caille Presents



On May 29th, Mr. Davies, Mr. Grant and Mr. Forrester hosted at La Caille an evening in recognition of Madame Volstad and Mr. Rennie's ten years at West Island in Calgary. The sculptures they were given as gifts are pictured with them above.

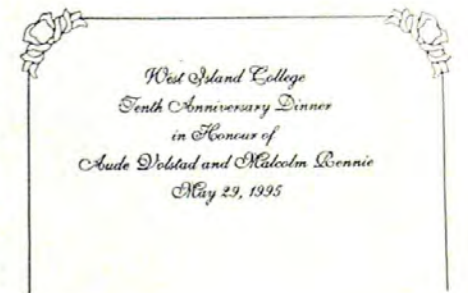

West Island College
Tenth Anniversary Dinner
in Honour of
Aude Volstad and Malcolm Rennie
May 29, 1995



Classroom Candid The Last Words

(CLOCKWISE FROM ABOVE):
"Abena standing by with the water, just in case". "What are you looking at?" "Attack of the French project!" "Elvis, are you there?" "Louise, what nice intestines you have!" "Just having a gab session." "Wow! This class is rockin'!" "You see, this is below this."



Keith & Associates

CONSULTING AUTOMOTIVE ENGINEERS

Suite 1020, 635 - 8th Avenue S.W. Calgary, Alberta T2P 3M3
Tel. (403) 292-0350 - Fax (403) 266-8843

Specialists in the Investigation & Analysis
of Motor Vehicle Accidents & Seat Belt Defense

- Automobiles
- Buses
- Level-crossing & Animal Collisions
- Bicycles
- Light Trucks

- Motorcycles
- Tractor-trailers

Investigation - Reconstruction - Expert Testimony

Peter G. Keith, M.Sc., P.Eng.

Greyhound, Canada
congratulates the graduates and students of
West Island College



McLeod & Company

Barristers and Solicitors

SOUTHCENTRE EXECUTIVE TOWER
SUITE 800 - 11012 MACLEOD TRAIL S.
CALGARY, ALBERTA, CANADA T2J 6A5

TELEPHONE (403) 278-9411
TELECOPIER (403) 271-1789

* Denotes Professional Corporation

- * RODERICK J. McLEOD, Q.C.
- * LARRY D. REVITT
- * ALLAN M. KOLINSKY
- * WILLIAM M. WALKER
- TERESA M. CARSWELL
- JACQUELINE R. HALPERN
- A. NEIL HUTTON
- ALASDAIR A. FRASER

- * ROSS A. KAPLAN
- * CHRISTOPHER G. THOMAS
- * PATRICK F. MAHONEY
- J. DEBORAH COPPOCK
- DARREN B. FACH
- ROBIN G. LOKHORST
- CHRISTOPHER F. LEE

GARRETT POWER

Chartered Accountants

Peter R. Garrett, B.Sc., C.A. 311. 1711 - 4th Street S.W.
Calgary, Alberta
T2S 1V8
Partner
Bus: (403) 228-9979
Fax: (403) 229-3064



Allan H. Graas

D.M.D., M.Sc., Dip. Ortho., M.R.C.D.(C)
Certified Specialist in Orthodontics

Suite 202, Southland Court
10601 Southport Road, S.W.
Calgary, Alberta, Canada T2W 3M6
Telephone: (403) 278-1933



Jokers Wild
Music For All Occasions

Contact: Dave Luker
Tel: 271 - 0894



Thomas F. Evans D.D.S.

234 Market Mall Professional Bldg.
4935 - 40th Avenue N.W.
Calgary, Alberta T3A 2N1

286-2622
Fax 286-3554
1-800-558-4416

Residential, Commercial, Industrial
Air Conditioning, Heating, Sheetmetal
Sales & Service

BILL JONES
Service Representative

A·D·S
AIR CONDITIONING
LTD.

Phone 235-0454
7 MALVERN CRESCENT N.E.
CALGARY, ALBERTA
T2A 5P3

West Island College
would like to thank the following
PATRONS
of Voyages - the 1995 Yearbook:

The Alexander Family
The Denoon Family
The Gillean Family
The Habermayer Family
The Lambert Family
The Steer Family
Southland Transportation, Ltd.

1995



Art above by Crystal Walker,
Grade Ten.

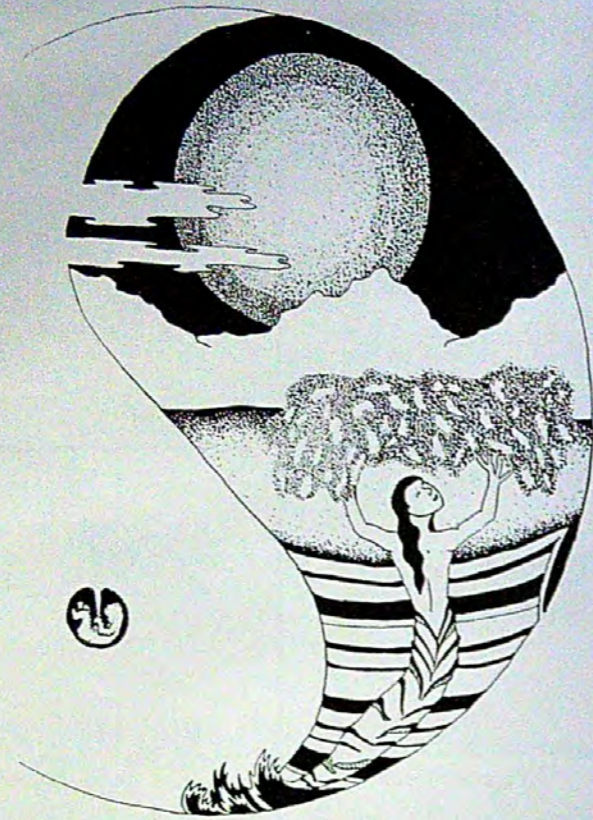

Closing page Art above by Liv Watson, Grade Ten



Time to put this edition of
the yearbook to rest.

Autographs